

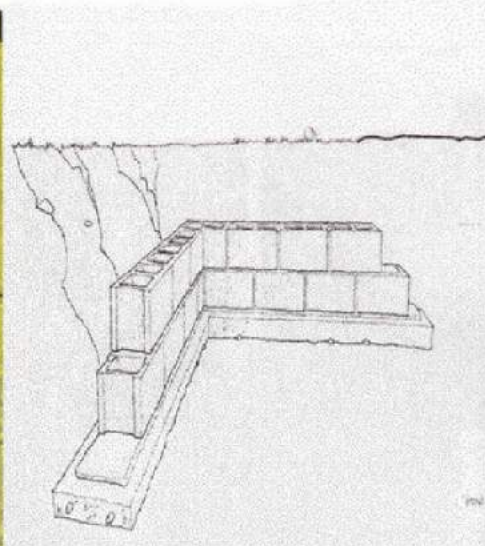

Free PDF hosted by
TRUEPREPPER
@trueprepper.com



BUILD A PROTECTIVE FALLOUT SHELTER



Almost weekly reports of North Korea's famine situation, China's threats to the US about "which is more important to you-Taiwan or YOUR west coast?", and middle eastern suicide bombers, as well as recent events within our borders. ALL bring us closer to the eventual possibility of someone/some group upgrading the stakes to a nuke threat. If YOU think that somewhere, sometime soon there will be another bombing, possible larger, than you should consider making a shelter for you and your loved ones close to your home.

Contents

Introduction	Page 3
Pre Planning & Information Phase	Page 4
High Protection Factor(PF)	Page 4
Radiation Basics	Page 4
Biological Weapons	Page 8
Ventilation	Page 13
Air Filtration	Page 15
Water	Page 16
Under Ground Water Systems	Page 17
Deposal of Human Waste	Page 14
Food	Page 19
Cooking And Heating	Page 21
Other Shelter Needs	Page 22
Construction Phase	Page 22
Foundation Layout	Page 22
Excavation	Page 25
Footings	Page 27
Working With Concrete	Page 28
Poured Concrete Shelters	Page 28
Concrete Block Shelters	Page 34
Floor Slabs	Page 30
Moisture and Thermal Protection	Page 39
Roof Slab	Page 41
Curing Concrete	Page 43
Shelter Plans	Page 44
Electrical Systems & Lighting	Page 47

Introduction

Having a permanent, ready-to-use, well supplied fallout shelter would greatly improve millions of American families' chances of surviving a nuclear or biological attack. Multi use family shelters - shelters that also are useful in peacetime - are the ones that Americans are most likely to build in normal peacetime and to maintain for years in good condition for use in a nuclear war.

The longer nuclear peace lasts, the more difficult it will be, even during a recognized crisis, to believe that the unthinkable war is about to strike us and that we should build expedient shelters and immediately take other protective actions. The lifesaving potential of permanent, ready-to-use family shelters will increase with the years. Americans who decide to build permanent shelters need better instructions than can be obtained from official sources or from most contractors. This guide brings together fallout shelter requirements, based on shelters and shelter components that have been built and tested in several states and nations. The emphasis is on permanent fallout shelters that many Americans can build for themselves. The author believes that millions of Americans can build good permanent fallout shelters or have local contractors build them - if they learn the shelter requirements outlined in the following sections of this guide and the facts about nuclear and biological weapon effects and protective measures given in preceding sections. Builders can use their skills and available local resources to construct permanent, dependable fallout shelters at affordable cost.

This guide has a basic set of plans. The plans call for using cinderblock foundation shelter with a poured concrete floor and roof. The plans may be altered to use a poured concrete foundation shelter using forms. This technique of form building is also covered in this guide. The basic plan has set dimensions but may be altered according to your situation. For example, adding an adjacent room for a diesel generator or a well. The building plans are in the back section in blueprint form. A basic understanding of reading blue prints are required. In other words how to add and subtract measurements using the English system of measurement. The plans are very easy to understand. The actual building techniques begin in the construction phase of this guide. Once the reader studies the building techniques discussed in the following sections, he or she will be able to relate to the detailed plans in the back of this guide. The author believes the reader should get a basic understanding on the planning stage. Many amenities can be added to the overall plan of your shelter. This of course depends on how much your willing to spend on the project. Local scrap yards can save you bundles on material costs. With the permission of the local construction manager, one may be able to obtain scrap building material from a large construction project.



PRE PLANNING & INFORMATION PHASE

A HIGH PROTECTION FACTOR(PF)

A permanent fallout shelter should be built - and can easily be built - to have a high enough protection factor to prevent its occupants from receiving fatal or incapacitating radiation doses, and also from receiving doses large enough to seriously worsen their risks of developing cancer in the years following an attack. Shelters with a protection factor of 40 (PF 40) meet the minimum standard of protection for public shelters throughout the United States, and permanent family fallout shelters described in official pamphlets provide at least PF 40 protection. In almost all fallout areas, PF-40 shelters would prevent occupants from receiving fatal or incapacitating radiation doses while inside these shelters. However, in areas of heavy fallout the occupants of PF-40 shelters could receive radiation doses large enough to significantly contribute to the risk of contracting cancer years later. Furthermore, the larger the dose you receive while in a shelter, the smaller the dose you can receive after you leave shelter without being incapacitated or killed by your total dose.

If you build a permanent shelter, you would be foolish to build a shelter with a PF of only 40 when additional protection is so easy to obtain. By making a shelter with a 6-inch-thick concrete roof covered by 30 inches of shielding earth, and with other easily attained design features shown in the plans in the back section, you can have a shelter with a protection factor of about 1000. (An occupant of a PF 1000 shelter will receive a radiation dose only 1/1000th as large as he would receive if he were standing outside in an open field during the same time interval.)

Radiation Basics

EMP Shielding

In 1999, eleven members of the US congressional delegation went to Moscow and met with members of the Russian Duma. They discussed ways of ending the US-NATO bombings in Yugoslavia. The Chair man of the Russian State Duma Foreign Policy Committee, Vladimir Lukin, made the following threat to the American delegation, "You have to understand that if we want to cause you a problem over this, we could. Someone, we don't know who, could send up a missile from a ship or a submarine and detonate a nuclear weapon high over the United States. The EMP [electromagnetic pulse] would take away all your capability." Electromagnetic pulse is a serious problem that every shelter builder should understand and make at least basic contingencies for. When a nuclear weapon is detonated in the high atmosphere, it produces an effect called EMP. In simplified terms, this is an electrical charge that collects on wires, cables, antennas, etc. and produces very high voltage for a fraction of a second. It is so fast that surge and lightning protectors will not stop it and it will damage any electronic equipment it travels to, even if the equipment is turned off. A basic solution is to keep sensitive equipment unplugged and stored in sealed metal containers. The sealed metal container will act as a shield against the pulse. Biological weapons may target living organisms or an environment seen as affecting the outcome of a struggle for control. These include humans, both soldiers and noncombatants, commercial crops and animals, the water supply, the soil, the air, or any combination of these. The object being, in each case, to weaken, terrify or punish the enemy to a degree which induces them to comply with the attacker's demands.

Radiological Monitoring

There are two deadly types of radiation—neutron and gamma—but for the most part, radiological monitoring involves measuring only gamma radiation. Neutron or initial radiation occurs for a few seconds in close proximity to the blast. Gamma radiation is the more deadly radioactive element found in radioactive fallout particles. Gamma radiation is the long-term (two- to six-week) problem which shelter occupants will have to contend with.

Equipment

Radiological monitoring is a two-fold activity. The first aspect involves measuring the amount of radiation received per hour, both inside and outside of a shelter. This aspect is referred to as determining radiation exposure rates and is accomplished with the use of a survey meter. The second aspect of

radiological monitoring involves measuring the total amount of radiation which people have been exposed to during a given period of time. This aspect is referred to as accumulated exposure and is measured with the use of a dosimeter and a dosimeter charger. Every shelter should have these three pieces of equipment!

Survey Meter

Radiation is an unseen, unfelt danger that can only be detected and identified with a survey meter. Survey meters are also referred to as dose rate meters and fallout meters. A survey meter is so named because it's used to scan, or "survey" an area or surface to determine the radiation exposure rate present. Survey meters measure the rate that people are being exposed to gamma radiation in terms of roentgens per hour (r/h). In short, a survey meter is somewhat like the speedometer in your car, but instead of telling you speed in miles per hour it tells radiation strength in roentgens per hour. It is kind of like a thermometer which tells you how hot the radioactivity is. Survey meters measure gamma radiation and some can detect beta radiation.

The National Academy of Sciences' Advisory Committee on Civil Defense in 1953 concluded: "The final effectiveness of a shelter depends upon the occupants of any shelter having simple, rugged, and reliable dose rate meters, [survey meters], to measure the dose rate, [rate of exposure], outside the shelter. "Most survey meters have a multiple range reading capability. In other words, they have some sort of selector knob which will change the scale to register and measure lower or higher levels of radiation exposure in roentgens per hour. For instance, an Autonnic AR model 81 survey meter has four ranges, 0 to 0.5 r/h, 0 to 5 r/h, 0 to 50 r/h and 0 to 500r/h.

If you took a reading at the 0 to 500 r/h and it hardly registered on the meter scale, you would turn the knob down to a lower scale which is in closer proximity to the exposure rate. You are not going to be able to get an accurate reading of radioactive fallout with a field strength of 4 r/h if you have the survey meter selector knob turned to the 0 to 500 r/h range. An accurate reading can only be obtained by turning to the 0 to 5 r/h range. If the field strength is stronger than the range you have selected, the needle will peg itself or run off the scale. This is an indication that you need to turn the selector knob to higher ranges until you get an accurate reading.

Rad Gun Survey Meter Outside / Inside Exposure Ratio

Radiological monitoring involves getting both inside (sheltered) and outside (unsheltered) readings of the radiation field strength in r/h with a survey meter. By making an initial survey, both sheltered and unsheltered preferably no more than 3 minutes apart, you can calculate an outside/inside exposure ratio. For instance, the unsheltered outside radiation exposure rate might be 1,000 r/h and the sheltered inside radiation exposure rate 2 r/h. You would divide the unsheltered exposure rate of 1,000 by the sheltered exposure rate of 2 and this would give you an outside/inside exposure ratio of 500. Later that evening you might take another inside or sheltered reading which registered 1.5 r/h. By using your pre-determined outside-inside exposure ratio of 500, you can determine the unsheltered exposure rate without having to subject yourself to the hazard of going outside and getting another reading. The outside unsheltered exposure rate can be fairly accurately estimated by multiplying the sheltered exposure rate of 1.5 r/h, by the outside/inside exposure ratio of 500, which would mean the unsheltered exposure rate would be 750 r/h (1.5 r/h x 500). The outside exposure rate will generally change proportionately with the inside exposure rate according to the outside/inside exposure ratio. Be advised that if you are getting sheltered exposure rate readings of over 2 r/h, you have a problem. Different parts of the shelter are apt to have different protection factors. Survey other parts of the shelter to see if there are other areas in the shelter which provide better radiation exposure protection where people can be moved to. If there is not enough room for everyone in the areas of better radiation shielding, rotate people in and out of protected areas to minimize, spread out, and balance out the overall radiation exposure rates. If you register an inside sheltered exposure rate reading of 10 r/h or more you are dealing with a potential life and death situation.

The outside/inside exposure ratio will change with time because the energy level or penetrating capability of gamma radiation changes with time. Also, rain and weather can physically shift concentrations of fallout material off the roofs of buildings and coverings over shelters and onto the ground. This rearrangement of fallout concentrations could affect the ratio for better or for worse. This is

why it is important to continually survey different parts of the shelter and recalculate ratios as much as is feasible and safe.

External Probe The Seven-Ten Rule

Another useful method for calculating the outside, or unsheltered rate of radiation exposure, is called the seven-ten rule. For every seven-fold increase in time after a nuclear weapons detonation, there is a ten-fold decrease in the radiation exposure rate. For example, if an initial reading is made one hour after a detonation with a survey meter showing a radiation exposure rate of 1,000 roentgens per hour, seven hours later (1 hour times 7) the exposure rate would be 100 r/h, forty-nine hours later (7 hours times 7) would be 10 r/h, and 343 hours later (49 hours times 7), which is a little more than 14 days, the radiation level would be 1 r/h. So in 14 days the outside radioactive fallout with an initial strength of 1,000 r/h would diminish to 1 r/h. Sources for Radiation Dosimeter and Dosimeter Charger A survey meter should not be confused with a dosimeter. They are two different things. A dosimeter is like your odometer, but instead of telling you how many miles you have traveled, it tells you the accumulated radiation you have been exposed to in roentgens. This is valuable in terms of delegating duties in exposed areas. Having a person wear a dosimeter during emergency conditions allows the shelter manager to make sure individuals don't get exposed to too much radiation. If the dosimeter indicates the individual has been exposed to the maximum safe accumulated radiation exposure, then the shelter manager should assign any task involving additional radiation exposure to another person who has not yet exceeded their safe radiation exposure limit. A dosimeter can detect and register accumulated radiation exposure over a given period of time. Anyone going on an outside mission or doing work in a poorly shielded area should wear a dosimeter so their accumulated exposure to radiation can be monitored. Be advised that no one should go on an outside mission unless the outside radiation exposure rate has reduced to 25 r/hr or less. Any outside missions when radiation rates are in excess of 25 r/hr could endanger the lives of those involved. Every outside mission should be evaluated in terms of critical importance, the exposure time required to accomplish the mission, and the rate of radiation exposure which the participants will be subjected to. The decision to undertake an outside mission should not be clouded or based on emotion but should be based on a logical evaluation. Such a logical evaluation would include calculating the potential accumulated exposure of any individual involved in the contemplated outside mission and comparing it against the accumulated exposure which potential candidates for the mission have already received. If a potential candidate will not exceed his maximum safe accumulated exposure, and if the mission is deemed critically important, then the mission could proceed as long as it is well defined and time completion deadlines are specified to prevent excess exposure.

Note: Any amount of radiation exposure will have an effect on the human body. People can have different reactions to the same dose of radiation. The absolute "safe" limit may be as low as 2.4 r for 24 hours. The human body has the ability to daily repair or compensate for a radiation exposure of 10 r. Pregnant women and children under 18 years of age should avoid any unnecessary radiation exposure. The fetus or unborn child is very susceptible to injury from radiation exposure.

A dosimeter is a pen-like object about 1/2 inch in diameter and about 4-1/2 inches long. Dosimeters have a clip on them, similar to the clip on a pen, so they can be clipped onto clothing. One end of a dosimeter has a magnifying glass that you look through and the other end has a contact which plugs into the dosimeter charger. Before a dosimeter can be used, it must first be recalibrated. While in storage, dosimeters tend to accumulate a false reading or calibration drift. Stored dosimeters should be periodically checked for calibration drift and recalibrated back to zero when necessary. Recalibrating is also referred to as zeroing. First remove the cap off the charging receptacle on the top of the dosimeter charger, and then press the contact end of the dosimeter firmly down into the charging receptacle. While looking into the magnifying end of the dosimeter, turn the control knob which is on top of the charger adjacent to the charging receptacle until the dosimeter reads zero. After using a dosimeter to check the accumulated dose of radiation a person has received, a reading of the dose needs to be taken and recorded. Once this exposure rate is recorded, the dosimeter needs to be zeroed-out again.

Decontamination

The best solution to the decontamination problem is to live near your shelter. Decontamination removes radioactive, biological or chemical contamination from the body surface of individuals who have been ex

posed to contaminants. The main purpose of decontamination is to prevent injury due to the presence of contaminants on the body surface. This is done by removing the contaminants as quickly as possible to minimize the potential of internal contamination through the penetration of broken skin, inhalation or ingestion. An additional purpose of decontamination is to prevent the spread of contaminants to adjacent body areas or to other people.

Radiation is the easiest contaminant to remove. Decontamination of an individual exposed to radioactive contaminants usually involves removing and discarding clothing, cutting off hair, scrubbing down with soap and water, and rinsing off the body surface. After this is done, the individual can be checked with a radiation meter to see if any radioactive material has been missed in the decontamination process. It should be noted that if the individual has ingested or inhaled radioactive particles, there is no practical means of internal decontamination. Generally, anyone who has ingested radioactive particles but has been decontaminated will not be a serious contamination threat to other people around them.

General Principles of Decontamination

Start Decontamination As Soon As Possible. Decontamination procedures should be instituted as soon as an individual enters the shelter. It is very important to have a decontamination area set aside in the entryway of the shelter, away from any further radiation exposure but before entering into the living quarters of the shelter. Contaminated areas of the body should be identified and differentiated from non-contaminated areas as early as possible. Triage

Decontamination should proceed based on established priorities of need. The highest priority areas are those with the highest levels of contamination. The next highest priority are wounds, since these might allow contaminated substances into the body. The third priority are body orifices: nose, mouth, ears, etc. for the same reason.

Only Do What Is Necessary

It is unnecessary to go into complex decontamination procedures if the initial simple ones are successful in eliminating the radioactivity. Use the more complex procedures only if they are warranted by persistent contamination readings. Be aware that it is virtually impossible to completely decontaminate the skin. Thus, don't go overboard in an attempt to attain absolute decontamination and try to use highly abrasive substances that could damage the skin.

Adequately Survey Victims

It is important to adequately survey victims both before initiating decontamination procedures and after completing them. A radiation level reading with a survey meter should be taken over the whole body when the victim arrives. It is also important to use a Q-tip or cotton swab on the nasal passageways and take a reading on this to determine the possible extent of inhalation of radioactivity and thus internal contamination. Before discontinuing the decontamination procedure, recheck the whole body with the survey meter as well as the nasal passages.

Decontamination Procedures for Internal Contamination

Internal radioactive contamination exists when radio-nuclide become incorporated within the body. In general, the major problem associated with chronic irradiation is that the organ affected may become cancerous. The following are the four steps radiation takes in the process of internal contamination. The only way radioactive fallout can get into the body is through the respiratory tract (inhaled through the nose or mouth), or through wounds on the surface of the skin. Radioactivity moves from its site of entry into the body either to the bloodstream or the lymphatic system. This is referred to as translocation. Once radioactive fallout gains access to the general circulatory systems, it tends to concentrate in specific organs. Radionuclide is removed from the body by the kidneys. They enter the bloodstream from the target organs or from the lymphatic system. As the blood circulates, it passes through the kidneys. There it is filtered and the radioactive particles are excreted into the urine with other body wastes. The quicker the process of internal decontamination can begin, the greater the chance of success, as damage from internal contamination is somewhat proportional to the length of time that the contaminant has been present internally. Whenever there is reasonable suspicion that internal contamination has occurred, begin treatment as early as possible.

The radiation can be most effectively stopped during entry deposition and translocation. There are very few forms of treatment available for preventing target-organ deposition or enhancing normal clearance mechanisms. If it has been determined that radio-nuclide are present in an open wound, three principles should be followed:

Be sure to protect adjacent areas from cross contamination during decontamination of the wound. Cleanse these areas with saline and then dry them. Cover them with adherent, non-absorbable wraps, such as an occlusive dressing.

1. Decontaminate the wound to minimize further contamination by repeated irrigations using normal saline or sterile water. Hydrogen peroxide can also be used as an irrigation. If the wound is allowed to bleed freely, this will flush out the contaminant, if necessary. Closure and dressing of the wound with a thick, absorbent dressing to prevent infection is the final step.
2. Initiate therapy aimed at reducing absorption and internal deposition and/or enhancing the excretion or elimination of absorbed nuclide. Potassium iodide can be used as a thyroid blocking agent (see chapter on The Effects of Nuclear War).

Decontamination Room

A decontamination facility should be a room or space isolated from the main part of the shelter. This room is usually situated at the end of an entryway where radiation shielding exists. The space should have a drain in the floor and preferably be a grated floor. The space should have running water, preferably warm, and hand-held shower sprayers. Electricity for hair clippers is useful but scissors will work. The decontamination room must have a survey meter and protective clothing and respirators for the decontamination staff. Plastic bags with twist ties should be stocked for containing the contaminated clothing and belongings. Tags should also be available to identify the bag's owner. The bagged contaminated items can be reutilized once the radioactive contaminants have decayed. Soap, towels and cleaning agents should also be stocked. Basic robes should be available to clothe the people who have gone through the decontamination process. If you have a small shelter, don't be overwhelmed with all these details. Just try to have running water, soap and shampoo available.

BIOLOGICAL WEAPONS

Having sealed gaskets on the doors and the vents will pay off if there is a biological attack near your shelter. Just remember the importance of waterproofing and sealing your underground shelter. This guide covers filters and traps in the following sections. Always supply your shelter with household bleach. Bleach will kill just about any microorganism.

Biological (and chemical) weapons are called the "Poor Man's Weapons of Mass Destruction". The modern weapons of war like the atom bomb, supersonic airplanes, atomic submarines and aircraft carriers all are horrendously expensive, technologically complex and require a large and sophisticated industrial capacity as well as a host of highly skilled scientists and engineers to produce and maintain. In contrast biological (and chemical) weapons production is relatively cheap, uses readily available commercial equipment and materials and can be managed by modestly trained scientists and technicians. A production facility for producing anthrax in weapon quantities could probably be set up in a small house, apartment or RV for less than \$100,000 and could be run by perhaps less than a dozen technicians with only the equivalent of a BS degree, operating under the direction of a single Ph.D. The basic knowledge for the growth of the majority of biological-weapons-grade microbes is freely available and the equipment and chemicals are obtainable from dozens of suppliers around the world.

ADVANTAGES

1. A single microbial bioweapon can, because it reproduces in the host, theoretically produce the desired detrimental outcome in a target host. That is, a single smallpox virus or plague bacillus, if deposited in the right place in the host, can grow and produce a disease. In practice it usually takes more than a single organism to establish an infection.

2. Biological toxins are among the most toxic agents known. For example, the quantity of botox in the dot of an 'i' is, when delivered properly, enough to kill ~10 people.
3. Most bioweapons grade microbes are relatively easy and inexpensive to grow. Their cultivation doesn't require large factories and can utilize common commercial equipment, such as that used in making cheese. While viral agents are more difficult to cultivate than bacterial agents, both can be cultivated by individuals with limited scientific training. Recent advances in the formulations of tissue culture media make the cultivation of viruses even easier. Just as certain illegal drugs are manufactured in mobile-van labs or marijuana plants are grown in buried semi-trailers, so it is possible to grow most bioweapons under similar, hidden and/or mobile, conditions. In fact those seeking bioweapons labs (e.g. the UN inspectors in Iraq) face the same problems as drug agents in the US searching for drug operations.
4. Large quantities of biological weapons can, in most cases, be produced in a short period (a few days to a few weeks) at small facilities scattered over a large area. Kathleen C. Bailey, a former assistant director of the U.S. Arms Control and Disarmament Agency, has visited several biotechnology and pharmaceutical firms. She is "absolutely convinced" that a major biological arsenal could be built with \$10,000 worth of equipment in a room 15 feet by 15. After all, one can cultivate trillions of bacteria at relatively little risk to one's self with gear no more sophisticated than a beer fermenter and a protein-based culture, a gas mask and a plastic over garment

DISADVANTAGES

1. Difficulty of protecting the workers at all stages of production, transportation, loading of delivery systems and final delivery: Untrained and inexperienced personnel, ignorant of routine precautions necessary to prevent contamination with the agents, are accident prone. Immunization of these personnel will not be effective in all cases.
2. Difficulty in maintaining quality control and sufficient containment during growth and harvesting of agents: Primitive conditions increase chances for the accidental release of the bioweapons into the surrounding environment (as happened in Russia with anthrax). Consider how much radiation has escaped from Hanford atomic weapons production plant during its history. Both examples represented state-of-the-art production facilities.
3. Effective delivery problems: Most biological materials, including spores, are destroyed by exposure to UV light and drying. Agents released in the air may disperse in unexpected ways due to the vulgarities of wind patterns. Dispersal patterns may be ineffectual. Rain may wash the agents out of the air before they reach their target.
4. Poor storage survival: Many biological weapons must be stored under special conditions to maintain efficacy. Further, they are often difficult to maintain in a weapons-delivery state (e.g. loaded and ready to be fired in a rocket). This means that the warheads must be taken from storage and attached to the rocket engine, during which time they are exposed to attack.
5. Difficult to control once released: One's own troops may be infected under the chaos of a war. In theory it may be possible to protect your own population against a BW you plan to use by vaccination or the prophylactic administration of antibiotics, but the chance that your enemy will discover what you're doing is high.

THE TOP BIOLOGICAL WEAPONS

With an abundance of potential biological weapons to choose from, what are the top choices and why? This is a difficult question to answer because of the extreme secrecy surrounding biological warfare. Based on what is known, combined with some reasonable assumptions, the following are prime suspects in this rogue's gallery of biological horrors:

SMALLPOX: Recently a number of stories have surfaced suggesting that many countries retain viable stocks of the smallpox virus and that some may even have large stores of this virus ready for delivery as a biological weapon. The smallpox virus is a prime candidate for a BW because of the

following characteristics:

1. It is a DNA virus whose genetic code has been sequenced.
2. It is easily (for a virus) cultivated and large quantities of the virus could be produced in a relatively short period of time. There is good evidence that Russia produced tons of smallpox during the cold war and there is some evidence that they still have it stored away.
3. It is a prime candidate for genetic engineering. It is easy to engineer it so that the current vaccines are no longer effective and to add virulence factors to the smallpox genome (e.g. botox gene) that would make it virtually 100% fatal.
4. It is highly infectious, being spread by close human contact. It can be contracted by inhaling the virus.
5. It is extremely hardy; surviving on fomites for days or weeks.
6. Most of the world's population is susceptible to this virus as routine vaccination was stopped when the WHO declared its eradication in 1979.
7. The mortality rate is strain dependant, however the mortality rate of the variola major strain is ~50%. It is likely that any BW-strain would have an even higher mortality rate.
8. There is no known treatment to abate the course of the disease other than routine medical care.

Although there is an effective vaccine against the wild type strain of this virus, the stocks of this vaccine are very low (7 to 10 million doses for a population of >260 million) and may have spoiled. Also, since it takes several days to 2 weeks after vaccination to develop full immunity, vaccination following a widely dispersed application of the virus would be unlikely to have any significant effect on the near-term spread of the disease. Even those of us who received the vaccine as children may have lost our immunization, particularly against genetically engineered highly virulent strains. One indication of a potential use of this BW would be the sudden vaccination against smallpox of the military of a perpetrator. However, as smallpox immunization is likely to be routine for the military in many countries (including possibly the US military), and it could be hidden as a part of normal immunizations, making it difficult to detect. Further, recent advances in vaccination, such as the ability to immunize people by feeding them transgenic plants (e.g. bananas) that produce one or more antigens, make it possible to immunize the majority of a population without them even knowing it.

ANTHRAX Another old favorite BW, *B. anthracis*, is an aerobic spore forming, gram positive bacterium that is highly infectious and lethal to man and many of his domestic animals. It is naturally contracted through wounds, commonly by farm workers, but it can also be inhaled. In the former case, it produces a large cutaneous wound which, if the bacteria reaches the blood stream, results in a fulminating septicemia that is usually fatal if untreated. Inhaled spores germinate in the lungs and produce a pulmonary anthrax which is rapidly fatal in 80% of the cases. The spores remain viable in the soil for many years and their presence there renders contaminated land virtually unusable for non-immune farm animals (and man) for years. Strains with increased virulence and resistance to antibiotics have been produced. For a lecture on anthrax visit [this site](#), [this site](#) or [this site](#) and to learn about a vaccination program visit [this defense site](#). Treatment consists of immunization for prevention and antibiotic treatment for an infection or as prophylactic treatment of soldiers likely to come into contact with the organism. Antibiotic treatment must be started quickly and continued for 60 days. Human immunization requires a two to three week lead time before exposure to anthrax. Troops in the recent war with Iraq were immunized against anthrax and all US soldiers are now (1999) routinely immunized against anthrax. However, in the case of pulmonary anthrax, treatment is of little use because of the virulence of the infection. The anthrax bacteria are easy to grow and can produce a lot of weapons-grade spores in a short time. The spores store well, probably in the delivery systems (e.g. rocket warheads) in the field. The Iraqis reportedly produced >2,000

gallons of anthrax and prepared 50 bombs and 4 missile warheads with this material. There is considerable doubt that they told us the entire truth?

BOTULINUM TOXIN (botox): Often touted as the most toxic substance in the world or at least in the biological world, botox is an obvious front runner. *C. botulinum* can be isolated from its natural habitat, the soil and it has been obtained from culture supply houses. It is an obligate anaerobe, which makes it a bit difficult to grow, but this presents no serious obstacle to a competent microbiologist. It grows rapidly on common bacterial media and the conditions for achieving optimum toxin production are well researched. Purification of the botox protein is not difficult. One suspects that by using new affinity column chromatography, gram quantities could be isolated in a day or less, or even on a continuous-flow basis. botox is relatively stable and can be stored in crystalline form, but the weapon-ready forms are classified. It can be absorbed through the mucous membranes so aerosol dispersal, addition to a municipal water or food supplies are likely ways of introducing botox into a population. It is tasteless and odorless and, depending on the dosage, and may take from 2 to 14 days before the symptoms appear. The symptoms include double vision, difficulty in swallowing and speaking, muscle weakness, vomiting and eventually respiratory failure. The protein is a neurotoxin and once the symptoms appear the damage is irreversible (after ~48 hours). There are several botox immunologically unique strains. The only treatment involves passive antibody shots against all the botox strains; the assumption being that a mixture of botox strains would be applied. Immunization of a large population is not considered feasible.

The advantages of botox is that since its symptoms are delayed, the damage is done (walking dead) before victims realize what has occurred. The amount of antiserum required to treat 100,000s of exposed people is not available, plus the fact that many people would be beyond saving even if given the antitoxin. The known disadvantages are that botox is unstable in the air if exposed to sunlight and dry conditions and is destroyed by brief boiling, thus effective exposure is limited by a small window of lighting and humidity conditions. Even though botox is highly toxic it would still take a large quantity to reach a lethal concentration in a large city's water supply. Further, contaminating a food supply would be difficult, although individual food processing plants are a likely target for terrorists. The centralization of huge food-processing plants that provide food for outlets around the country offers terrorists a tempting opportunity to commit mass murder.

A realistic view of the botox situation is that many of the problems of dispersal were likely solved by the >3,000 US scientists that reportedly worked on biological warfare during W.W. II & the cold war. It is also reasonable to assume that the botox can be fused by common molecular biology technology with other proteins that stabilize it for dispersal without decreasing its lethality or it can be mixed with other protective agents (e.g. trehalose, viral-glass) or that it can be encapsulated in protective material (timed release) that dissolves once it is in the digestive system. It should also be possible to clone the botox gene into common bacteria that inhabit the human gut (e.g. *E. coli*), which would establish themselves there long enough to produce a quantity of botox sufficient to disable the victim before their immune system responded; a natural condition seen in young babies who ingest the spores in foods like honey. For a chilling description of how this might be done visit the Cal Poly site. The Iraqis own up to producing ~5,000 gallons of *C. botulinum*, but the yield of botox was not reported. Other nations like Iran, Syria, North Korea and Libya are suspected of being in the biological weapons production business. Further, it is unclear what has happened to the massive Soviet Union's biological weapons' production facilities and their BW-arsenal since the breakup of the Soviet Union.

AFLATOXIN: This is a class of biological carcinogens, product by certain molds, that induce liver cancer. Man and many other animals are susceptible to this material. The molds that produces this material grows well on grain, peanuts and other rich nutrients. Aflatoxins are readily extracted with ethanol and easily concentrated. They are stable on storage, but their stability after dispersal has not been reported. The onset of the cancer is uncertain and clearly dose dependent. As there are no known human tests on the toxicity of this material, it is impossible to assign a minimal lethal dose.

Since there is a delay between exposure and the development of the clinical disease, as well as difficulty in differentiating cancer origins between accidental and intentional exposure, even recognizing that a target

population had been "attacked" would be laborious; this would be a case of a "stealth BW attack". The Iraqis reportedly produced ~600 gallons of concentrated aflatoxin which was loaded in bombs and missiles.

Clostridium perfringens: The Iraqis produced 90 gallons of this microbe. *C. perfringens* is an anaerobic gram positive spore former that grows well in the absence of oxygen and produces spores resistant to adverse conditions. It enters the body through wounds, particularly the jagged, deep, and dirty type produced in war, where it cause gas gangrene. Gas gangrene is an especially nasty disease that eats away the body while producing a stench that would gag a maggot. It is one disease that physicians can diagnose a block away from the patient. Since *C. perfringens* is a natural inhabitant of the human intestine as well as most other animals it is not hard to obtain. It also is one of the most common agents of food poisonings, frequently spoiling foods like turkey and other fowl as well as any rich food it contaminates. Little has been reported about its delivery, its survival once dispersed etc., but a working assumption is that it would behave similar to anthrax in those respects. Since *C. perfringens* produces a host of toxic proteins, it is likely that super "hot" strains have been isolated for use as BW, and perhaps the toxin genes have been cloned for use as BDBS.

Treatment involves antibiotics and exposure of the patient to pure oxygen which inhibits the growth of the bacillus. However, as this latter treatment involves individual pressure chamber, it is not a reasonable treatment for an infected population.

RICIN: Ricin is a protein toxin (view with the helper application Chime) extracted from the castor bean plant. Ricin kills by destroying an important component of the protein synthesizing machinery of cells, the ribosome. It works as a slow poison, eventually causing a total body collapse as necessary proteins are not replaced. The structure and mechanism of action of ricin is well understood, thus making it an excellent candidate for genetic manipulation. That is, because of this knowledge, it should be possible to genetically modify ricin so as to make it a more effective BW. Ricin is already being investigated for its "magic bullet" properties as an agent that might selectively destroy cancer cells. This same technology could easily be applied to improving its BW-capacity. For example, if ricin is chemically bound to antibodies that only bind to a certain type of cancer cell, the attached ricin should only kill the targeted cancer cells and no other cells. The same principle could be used to specifically target an enemy; in theory one could be specific enough to use this procedure to target a single individual for assassination.

The delivery issues of ricin are probably similar to those for botox and are clouded in the same cloak of secrecy. It is reasonable to assume that relatively effective dispersal methods are available for delivering this toxin to a population and further, that since the components of ricin are being genetically manipulated for a variety reasons, that one of these uses might involve Black Biology.

In theory it is possible to immunize against the ricin protein, but I know of no source of an appropriate vaccine, although it should not be difficult to produce one; the problem is preparing it in quantity ahead of time (like the flu vaccine every year) and inoculating the target population far enough in advance. I know of no effective treatment once the ricin has produced clinical symptoms (similar to the botulism toxin story).

Fusarium oxysporum: The potential use of genetic engineering in the production of biological weapons is illustrated by the on-going studies on the possible of the use of the mold *Fusarium oxysporum* as a candidate for drug plant eradication. (28) This fungus, which has devastated commercial crops (e.g. bananas & muskmelon), is being investigated for its potential to destroy coca and cannabis plants, from which cocaine and marijuana are derived. Preliminary studies indicate that host specificity is narrow and species "jumping" is rare; i.e., targets can be carefully selected without posing danger to other commercial crops. However, its use in the U.S. could devastate the economies of several regions of the U.S.

Obviously, the same technology could be applied by terrorists to assail the commercial crops of perceived enemy states. Natural outbreaks of plant epidemics have repeatedly demonstrated, that the potato, corn, wheat and soybean mono-culturing techniques used to cultivate these crops offer optimal conditions for the spread of plant pathogens. Not only could rogue nations do this, it is possible (as depicted in James Bond movie, *On Her Majesty's Secret Service*) that a criminal organization, such as a drug cartel, with its vast

cash and organizational resources, could engage in such activities as retaliation for its economic losses. It is even possible that terrorists/criminals might hold a nation(s) up for ransom with the threat of using such a weapon.

Assuming that the research is successful and target-specific *F. oxysporum* strains are developed, they would then be employed, to destroy coca and cannabis crops. The mold pathogen's spores could be disseminated by conventional aerial crop-spraying techniques, by ground personnel or by small, self-propelled robots dropped into an area and guided by satellite to the targets (see below; Delivery of BW). Since it is known that environmental conditions, such as temperature, humidity, cloud cover etc. effect the efficacy of fungal diseases, release could be coordinated with satellite weather data. Bands of robots, equipped with analytical tools, could roam the countryside seeking out targeted crops on which they release their biological agent; i.e., chemical sensors that pick up the emanations from target plants would follow the gradient of the identifying substances to its source—much as insects do.

Once the fungal genes involved in target specificity are known (through gene mapping and sequencing) and their manipulation becomes routine, new fungi strains could be developed rapidly to counter resistant cultivars constructed by the drug cartels. It is possible that a biological-arms race could occur with victims developing resistant plant cultivars and drug-agencies countering with new-strains of the pathogen capable of attacking the new plant varieties—ad infinitum.

Ventilation

Official Atomic Energy Commission tests held in Nevada in 1950 showed that in the area where pressures reached 30 pounds per inch, a one-half-inch pipe was bent to the ground and the valve handle, stem, and bonnet were blown off. At the same location two 4-inch ventilating pipes were sheared off just below ground level. Pressures up to 30 psi are encountered from a 20-megaton blast up to three miles away from ground zero. vertical vents on shelters as shown in CD plans, would have a good chance of being cut off or bent to the ground, leaving the occupant of the shelter with no air supply. If your shelter is to be located within 20 miles of a potential target, it seems prudent to this author that the owner of such a shelter install a type of ventilating system that would be protected from such hazards. A system of retractable vents would work nicely, but the Atomic Energy Commission has advised that the cost for a safe system of this type would be much too high for the average shelter owner.

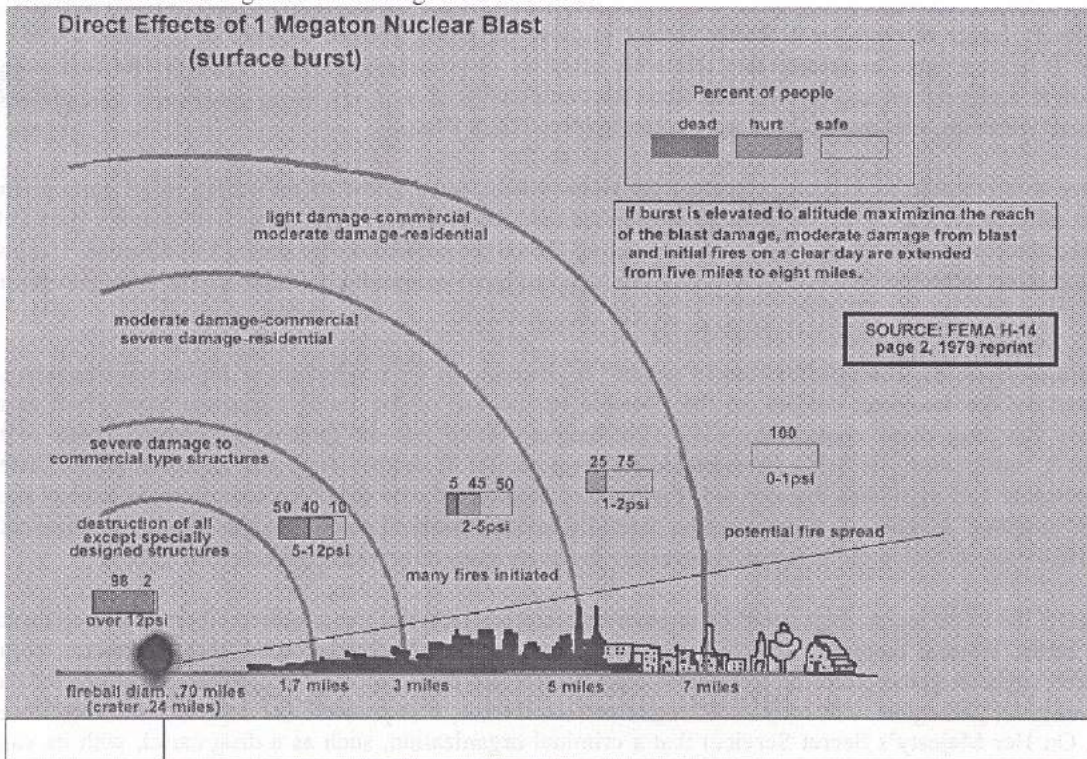

A relatively inexpensive method for providing air through a ventilating system safe from high winds and pressures is an underground type. By using a natural embankment, or making one at the edge of your yard, you have a vent come into your shelter under the ground. This vent is of the type used on hot-air furnaces, and it can be made of aluminum by any metal shop. Aluminum should be used to prevent rusting of the buried unit. A large diameter pipe could also be used but there are two reasons for the rectangular type. A coal chute door of steel can be attached to the outside end of the vent. This can be shut from the inside during the most severe conditions; it can then be opened from the inside to allow air to enter the shelter. It will also accommodate a fiberglass filter used on furnaces. You can have the vent made as large as you like, but a 20x25-inch opening should be the limit. Of course, the larger the vent the larger the air flow. The entire vent system is braced at least three feet underground by a frame of 2x4's. Attached to the frame is a series of pulleys for opening the steel door from inside the shelter by a 4-inch steel rope. Another steel rope runs down inside the vent to close it. Another use for the vent might be for an emergency escape hatch, in the event the shelter door was damaged by blast, or was blocked by debris. The steel rope, normally used to close the steel vent door, would then be used to allow a person to pull himself up through the vent. The vent would enter the shelter near the floor level, and a similar vent, near the ceiling of the shelter, could be used to carry off stale air, smoke, or fumes. This second vent could easily be a round stovepipe made from aluminum, and available from suppliers ready made. The exhaust vent should also have an air filter on it, too. The outside ends of all vents should be shielded from above to keep fallout from coming down the vents line. Fallout particles are about the size of an average grain of salt or sugar, reduced in size from one tenth to one half. They are in the shape of small spheres or teardrop shaped cinders or ashes. These particles settle to earth the same as dust and enter the same places dust can. To keep these specks of radioactive dust from entering the shelter with pure air, a filtering system is needed. Filters of glass fiber block or other fibrous material is very effective for this job. Inexpensive filters of fiberglass that are used for a home furnace are of this type. Filters are also commercially available which have been designed for shelter use. A blower, either hand operated or electrically driven can be attached in the shelter to pull air in at a faster rate than will normally flow into the shelter.

Adequate air supply is as important a consideration as shielding against radiation. Without a continual fresh air supply, shelter occupants will quickly perish from CO₂ poisoning. If you want your shelter to have adequate air filtration, with an operational capacity of 60 days or more, power generation will be required. Pulling air through a good filter bank produces a pressure drop. It is not feasible to draw air through a filter with a hand crank blower. Besides the difficulty of continually turning the blower 24 hours a day, the increased level of activity results in more oxygen being consumed, more CO₂ being produced, and more heat being generated.

Adequate amounts of air are required, not only for supplying the occupants with their chemical requirements (supplying oxygen and removing CO₂), but also for environmental requirements (controlling temperature and humidity levels). The average human body needs about 0.25 CFM, (cubic feet per minute), of oxygen to support life. In the process of breathing people consume oxygen and produce carbon dioxide proportionate to their level of activity. The concern for adequate air supply is not limited to the issue of oxygen supply. It is also a matter of maintaining a bearable condition in the shelter. The three critical elements which must be conditioned or controlled in the shelter's interior atmosphere are dangerous levels of CO₂, heat build-up, and high levels of humidity. This can be accomplished through mechanical air conditioning or, in some cases, simply ventilating the shelter with an adequate volume of outside air. This is fairly critical in smaller shelters which do not have any air conditioning / cooling equipment. Smaller shelters are many times reliant on earth cooling or mass transfer to the surrounding soil.

The U.S. Department of Defense recommended minimum shelter ventilation rate per person is 4 CFM. This is supposed to provide adequate oxygen, control dangerous levels of carbon dioxide, and meet tolerance limits for heat, cold and humidity. The reality is that 4 CFM probably means keeping CO₂ at high "headache" levels, temperatures just under 100 degrees and humidity potentially as high as 100 percent. This low rate of ventilation is questionable in most locations in the United States. It is advisable to have at least a minimum of 5 CFM or 300 CFH, (cubic feet per hour) per person, and have some sort of air conditioning equipment. The minimum rate of fresh air flow required to control heat and humidity will be greater than the fresh air required to control oxygen and carbon dioxide levels. The governing factor in determining the required volume of fresh air, or the ventilation capacity, for a shelter, then, is the control of

heat and humidity. This being the case, the air volume must be based on meeting the ventilation requirements during hot weather conditions. People feel comfortable when the relative humidity is between 20 and 60 percent. The mean air temperature at which people feel comfortable is about 77 degrees F. The temperature and humidity that will develop in a shelter are determined by the heat and moisture balance.

Another aspect of air supply to consider is the placement of the incoming air duct in relation to the generator exhaust duct. If the generator exhaust pipe is upwind of the incoming air duct, you will be in danger of contaminating your incoming fresh air with carbon monoxide. Try to place the generator exhaust pipe as far away from the incoming air duct as possible and in a positional relationship which will be least prone to cross contamination due to wind patterns. Also, if your engine room has a separate air system specifically for cooling the diesel generators, make sure that the resulting heated exhaust air is far enough from any air intake ducts that you are not recycling this heat back into the shelter.

Special attention should be given to the configuration of the surface portion of your incoming and exhaust air ducts. The two major concerns are vulnerability to blast effects and vulnerability to sabotage and tampering. Also, considerations should be made for the height that the incoming air duct extends above the ground. You definitely don't want the air supply cut off by drifting snow, volcanic ash, etc. If your air is cut off you can only stay in the shelter for as long as the CO₂ level inside remains safe. At a certain point, when CO₂ levels get too high, you will have to open the door and face the hostile environment outside or perish. The normal amount of air drawn into the shelter for meeting chemical requirements can be temporarily eliminated or reduced if the shelter has either a capacity to mechanically scrub CO₂ out of the atmosphere or if the shelter has some compressed air reserves. Only a small portion of the air we breathe is oxygen. Air is basically a mixture of two gases, being approximately 23 parts oxygen and 77 parts nitrogen.

Circumstances could arise where the occupants of a shelter may be forced to completely close up a shelter and discontinue bringing in fresh air from the outside. These circumstances might include sabotage, surface fires, blast effects, concentrated contaminants, biological, etc. This being the case, the shelter occupants will either have to make do with the volume of air contained in the shelter for as long as possible, or have some way of removing carbon dioxide and/or supplementing the oxygen supply. In a non-active mode, a person produces .67 cu. ft. of CO₂ per hr. and a 3% concentration of CO₂ is the ceiling of the safe limit.

An air scrubber is a filtering system that removes carbon dioxide from the air. Air scrubbers utilize either sodium hydroxide or lithium hydroxide as the filtering agent. Sodium hydroxide seems to be preferable for shelter operations because it is less caustic. A shelter can extend the amount of time that it can remain sealed if it has the ability to remove the CO₂ from the air. In a sealed shelter situation, CO₂ reaches dangerous levels long before the oxygen is depleted. For example, if a shelter had enough interior cubic air volume to maintain a sealed environment for three hours before CO₂ reached dangerous levels, then they would have enough remaining oxygen to continue maintaining a sealed environment for about nine hours as long as they had the ability to scrub the CO₂ out of the air.

Air Filtration

Air filtration is probably the third most important element in any shelter following radiation shielding and air supply itself. During a nuclear disaster, the bulk of the airborne contaminants is made up of radioactive fallout which is carried through the air by dust particles. At the minimum, you should be able to filter airborne dust contaminants out of the incoming air supply. This can be done with a HEPA filter. If you are planning a shelter in close proximity (within 10 miles), to a known target area, you may have to deal with more serious contaminants in the air. Other serious airborne contaminants—such as chemical war gases, biological agents, and radioactive iodine gas—can be filtered out of the air by more sophisticated carbon air filtration equipment. Carbon filtration involves a series of filters. My advice is that before investing in sophisticated carbon air filtration equipment, consider distancing yourself and family from any potential target.

The air filtration process can be implemented to its ideal, if resources are available, or implemented to its minimum, depending on the budget available and the level of protection desired. Nuclear airborne contamination threats fall into two categories: radioactive fallout, and radioactive iodine gas. Radioactive fallout particles are carried by airborne dust particles. If you can filter the dust out of your incoming air supply, you have taken care of the radioactive fallout problem. The removal of airborne dust particles from your incoming air supply is the easiest and least expensive form of filtration to implement. The removal of radioactive iodine gas, on the other hand, is more complex and more expensive. The potential of guaranteeing complete removal under all circumstances is less reliable. Radioactive iodine gas is a by-product of the "blast" and its presence would only be experienced within ten miles of the detonation of a nuclear device. Its presence, under the worst circumstances, could last up to three days. Fallout shelters located more than ten miles from a known target area shouldn't be concerned about radioactive iodine gas. Complete nuclear air filtration may or may not remove all the radioactive iodine from the air. The effectiveness of radioactive iodine filters depends on how concentrated the iodine gas is in the incoming air and how quickly the filtering agent becomes saturated with radioactive iodine. Once the filter medium becomes saturated, it starts to diminish its absorption and removal of the contaminants from the incoming air. The best solution is not to bring any outside air into the shelter for twenty-four hours or so. The problem with not taking in air from the outside is that CO₂ levels start building to life threatening levels at a variable rate which is dependent on the number of occupants that are in the shelter, the cubic volume of air contained inside the shelter, and the occupants activity level. So the first requirement for safely sealing up your shelter for any length of time is having a CO₂ monitor to determine when CO₂ levels have become dangerous (see section on CO₂ Monitor). At this point, either outside air would have to be induced into the shelter or an available reserve of compressed air would have to be tapped and released to displace the CO₂ concentrations which have built up in the shelter. The other option, as we have previously discussed, is to scrub the CO₂ out of the air with the use of either sodium hydroxide or lithium hydroxide.

Contaminant Particle Size

One thing that we need to understand when we are talking about filtering systems is the relative size of the material we are trying to filter out of the air. In general, contaminants are measured in microns. One micron equals 1/25,000th of an inch. To give you a comparative idea, 50 microns is equal to the size of a sharp pencil dot. Generally speaking, air filtration is not accomplished by one filter but by a combination of a series of filters.

Blast valves are used to protect the inhabitants of the shelter from sudden increases in overpressure which accompany and are the result of the detonation of a nuclear device in close proximity to the shelter. These valves not only protect against positive pressure but also negative pressure which follows immediately after the initial overpressure. These valves typically close off the incoming air and exhaust ducts at 3 lbs. of overpressure. There may be situations other than overpressure in which the inhabitants of a shelter might need to close off or seal the incoming and exhaust air ducts. This closing up of all connection to the outside is generally referred to as buttoning up. One reason to button up is an extremely high level of contaminants outside. Another reason would be people on the surface intentionally trying to tamper with or pollute the shelter's incoming air duct. There are blast valves that act both as a blast valve and a buttoning-up gate valve. It is advisable that the blast valve is located where it can't be tampered with by disgruntled people on the surface and where the inhabitants can service it if it jams or malfunctions. If you are not building a blast shelter you don't need a blast valve, but you should have some sort of valve to isolate the shelter from the outside environment if necessary.

WATER

° Water needs: Even most well-maintained shelters do not have enough water for prolonged occupancy. A permanent shelter should provide each occupant with at least 30 gallons of safe water - enough for an austere month, except in very hot weather.

° Containers: The most practical water container for shelter storage is a 5-gallon rigid plastic water can with a handle, a large diameter opening for quick filling and emptying, and a small spout for pouring small quantities. A 5-gallon water can of this type sells for about \$5 in discount stores.

The plastic bottles that household chlorine bleach is sold in also are good for multi-year storage of drinking water, as are glass jugs. Plastic milk jugs are not satisfactory, because after a few years they often become brittle and crack. Some shelter owners do not realize that, although a shelter can be kept dry in peacetime, except in the arid West its air is likely to become extremely humid after a few days of crowded occupancy. Very humid air soon softens and weakens cardboard containers of food and flexible water bags.

◦ Disinfecting for multi-year storage: To store safe water and keep it safe for years, first disinfect the container by rinsing it with a strong solution of chlorine bleach. Then rinse it with safe water before filling it with the clear, safe water to be stored. Next, disinfect by adding household bleach that contains 5.25% sodium hypochlorite as its only active ingredient. To 5 gallons, add 1 scant teaspoon of bleach. Finally, to prevent possible entry of air containing infective organisms through faulty closures, seal the container's closures with duct tape.

◦ Making efficient use of storage space: A 5-gallon rigid plastic water container typically measures 7 x 12 x 21 inches, including the height of its spout. Nine such 5-gallon containers can be placed on a 2 x 3-foot floor area. Twenty-seven 5-gallon containers, holding 135 gallons of water, can be stored on and over 6 square feet of floor if you make a water storage stand 24 x 42 x 48 inches high, built quite like the seat with overhead bunk described in the Seats/Bunks/ Shelves section of this chapter. This easily moveable storage stand should have two plywood shelves, one 24 inches and the other 48 inches from the floor.

◦ Using filled containers for shielding: Filled 5-gallon water containers can be moved quickly to provide additional shielding where needed to increase the protection factor of all or part of a shelter. For example, near the inner door of the shelter illustrated by in the drawings in the back of this guide, the protection factor is less than 1000. But if enough filled water containers are placed so as to cover the door with almost the equivalent of an 18-inch-thick "wall" of shielding water, the PF of the part of the shelter room near the door can be raised to about PF 1000.

If a shelter has twenty-seven 5-gallon cans of water stored on and under the above-described 2-shelf water storage stand, then in less than 3 minutes 2 men can shield the shelter door quite adequately. All they have to do is take the 18 cans off the shelves, put 9 of them on the floor against the door and doorway, move the storage stand over the 9 door-shielding cans, and place the remaining 18 cans on the stand's 2 shelves.

Equally good doorway shielding can be provided by placing at least a 24-inch thickness of containers full of dense food, such as whole-grain wheat or sugar, against the doorway. Two 55-gallon drums of wheat, each weighing about 400 pounds, can be quickly "walked" on a concrete floor and positioned so as to shield the lower part of a doorway. Heavy containers on the floor can provide a stable base on which to stack other shielding material.

Under Ground Water Systems

Local water sources: Most Americans' normal piped water would not run for months after a large nuclear attack. A month's supply of water stored in your shelter should be adequate, because, even if your area has heavy fallout, in less than a month radioactive decay will make it safe to haul water from nearby sources.

An important part of your shelter preparations is to locate nearby wells, ponds, streams, and streambeds that when dry frequently have water a foot or two below the surface. The author has found that digging a water pit in an apparently dry streambed often supplies enough filtered water to satisfy several families' basic needs. To keep the sides of a water pit dug in unstable ground from caving in, you should drive a circle of side-by-side stakes around the outside of your planned pit before starting to dig. If you are in a fallout area, before drinking water from a water pit you should filter it through clayey soil to remove fallout particles and dissolved radioactive isotopes, as described in the Water chapter. Of course it is prudent to chlorinate or boil all surface and near-surface water after it has been filtered.

A water well: The best solution to the water problem quite often is a well inside the shelter. In many areas the water table is less than 50 feet below the surface, and a 50-foot well, cased with 6-inch steel pipe, can be drilled and completed for about \$2000. Well drilling should be done after the shelter excavation has been dug and before the concrete shelter floor has been poured. An in-shelter well would be of vital

importance not only to the occupants of a family shelter, but later on probably to nearby survivors. Even if only a gallon or so an hour could be bailed from a well too weak to be useful in peacetime, it would be a tremendous family asset post-attack. If infective organisms are found in water from a well drilled to provide water during and after an attack, safe water for months can be assured by merely storing a few gallons of household chlorine bleach. If enough water for worthwhile peacetime use can be pumped from a well, install a submersible electric pump, with plastic pipe in the well. Then in an emergency the pipe and the attached pump can be pulled by hand out of the well, with only a saw being needed to cut off lengths of the plastic pipe as it is pulled. After the well casing has been cleared of pump, pipe and wires, a homemade 2-foot-long bail-bucket on a nylon rope can be used to draw plenty of water.

Another option is to have another small shelter close or adjacent to the main shelter that houses the well. This way you have your water supply protected. The well shelter could have a water holding tank several feet above the floor in the shelter. The water is pumped into the holding tank. Now the difference in height of the water level in the tank and the tap in the main shelter would produce a pressure head. A toilet could be placed in the shelter with running water. A shelter built into a hill side or on a slope has ideal conditions for independent running water. On the higher end of the slope you will have your water source. The lower end of the slope you can install a small cesspool for wastewater.

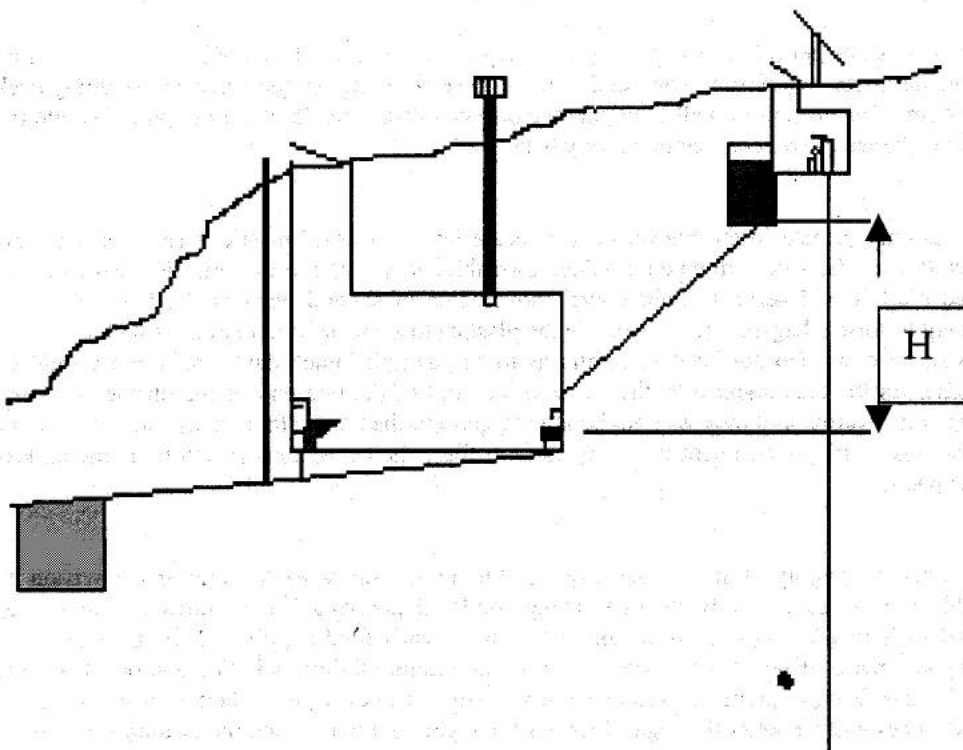

Deposal of Human Waste

Not everybody will have the luxury of installing running water and a toilet. To preserve health and morale in a shelter without a toilet or special chemicals for treatment of excrement and urine, human wastes should be removed before they produce much gas. A garbage can with a lid or a bucket covered with plastic will not hold the pressurized gas produced by rotting excrement. The following expedient means of disposal are listed in increasing order of effectiveness.

° Use a 5-gallon paint can, a bucket, or a large waterproof wastebasket to collect both urine and excrement. Use and keep it near the air-exhaust end of the shelter. Keep it tightly covered when not in use: a piece of

plastic tied over the top keeps out insects and reduces odors. When such waste containers are full or begin to stink badly while covered, put them outside the shelter still covered to keep out flies.

For some people, especially the aged, bringing a toilet seat from home would be justified. Padding on the edge of the bucket also helps those who have to sit down. An improvised seat of plywood or board serves well. If only one container is available and is almost filled, periodically dump the wastes outside unless fallout is still being deposited. Before an anticipated attack, people who plan to stay in a shelter should dig a waste-disposal pit if they do not have sufficient waste containers for weeks of shelter occupancy. The pit should be located about 3 feet from the shelter in the down-wind direction. This usually will be the air exhaust end of an earth-covered shelter. The pit should be surrounded by a ring of mounded, packed earth about 6 inches high, to keep surface water from heavy rains from running into it.

Quickly putting or dumping wastes outside is not hazardous once fallout is no longer being deposited. For example, assume the shelter is in an area of heavy fallout and the dose rate outside is 400 R/hr enough to give a potentially fatal dose in about an hour to a person exposed in the open. If a person needs to be exposed for only 10 seconds to dump a bucket, in this $1/360^{\text{th}}$ of an hour he will receive a dose of only about 1 R. Under war conditions, an additional 1-R dose is of little concern.

If the shelter design does not permit an occupant to dispose of wastes without running outside, he can tie cloth or plastic over his shoes before going out, and remove these coverings in the entry before going back inside the shelter room. This precaution will eliminate the chance of tracking "hot" fallout particles into the shelter, and the small chance of someone getting a tiny beta burn in this way.

° Have all occupants only urinate in the bucket, and defecate into a piece of plastic. Urine contains few harmful organisms and can be safely dumped outside. Two thicknesses of the thin plastic used to cover freshly dry-cleaned clothes will serve to hold bowel movements of several persons. Gather the plastic around the excrement to form a bag-like container. Tie the plastic closed near its upper edges with a string or narrow strip of cloth. Do not tie it so tightly as to be gas-tight. Each day's collection should be gently tossed outside. As the excrement rots, the gas will leak out of the tied end of the plastic covering. Flies will be attracted in swarms, but they will not be able to get into the plastic to contaminate their feet or to lay eggs. And because rotting excrement is so attractive to flies, shelter occupants will be bothered less by these dangerous pests.

FOOD

° Advantages of a one-year supply: A family that expends the money and work to build and provision its own shelter should store a year's supply of long-lasting foods. If post-attack conditions enable you to continue living and making a living near your home, having a year's food supply will be a tremendous advantage. And if your area is afflicted with such dangerous, continuing fallout radiation and/or other post-attack conditions that surviving unprepared residents are soon forced to evacuate to better areas, then your and your family's chances will be better if hunger does not force you to move during the chaotic first few months after a nuclear attack.

° Costs of a one year food supply for a family shelter: Table 17.1 shows the wide range of 1987 costs of the basic survival foods for multi-year storage that are listed and explained on page 88.

The delivered costs listed in the right hand column include UPS shipping charges in the nearest and least expensive of UPS's 8 zones. For UPS shipping costs to the most distant points in the 48 states, add 34 cents per pound delivered. All the foods in this survival ration, if stored in moisture-proof and insect-proof containers (the non-fat milk powder should be in nitrogen-packed cans), will provide healthful nutrition for at least 10 years. The exception is the multi-vitamin tablets, which should be replaced every 2 or 3 years, depending on storage temperature. So a family that spends about \$300 per member on such a one year survival ration can consider that each of its members has been covered by famine insurance for \$30 a year.

Scurvy will be the first incapacitating, then lethal vitamin deficiency to afflict unprepared, uninformed Americans. A multi-vitamin tablet contains enough vitamin C to fully satisfy the daily requirement. However, a prudent shelter owner also should store vitamin C tablets, that keep for years. One hundred 500-mg generic vitamin C tablets -50,000 mg of vitamin C - in 1987 typically cost about \$1.20 in a discount store; a 10 mg daily dose prevents scurvy. After a nuclear war in some areas vitamin C will be worth many times its weight in gold.

* Wheat: If you live in a wheat producing area, the least expensive sources of ready-to- store wheat usually are local seed-cleaning firms. A hundred pounds or more of hard wheat, dried, bagged, and ready to store in moisture proof containers, costs about 10 cents a pound. (Today the wheat farmer receives about 4.5 cents a pound for truckloads, usually straight out of the field, not dry enough to store except in well ventilated granaries, and containing trash that makes weevil infestations more likely.) In some communities a few stores sell big bags of dry, cleaned hard wheat for 20 to 35 cents a pound.

Shelter owners who are unable or unwilling to obtain wheat from such sources can buy high protein hard wheat at higher prices from health food stores and a few mail order companies. The lowest mail order FOB price known for hard western wheat in 1990 is \$3.17 for 10 pounds, in a vacuum-packed metallized plastic bag similar to the containers used for some U.S. Army combat rations. This long-lasting wheat, as well as other grains and legumes, is sold by Preparedness Products, 3855 South 500 West, Salt Lake City, Utah 84115. Another reliable mail order source of wheat and other dry foods packaged for multi-year storage is The Survival Center, 5555 Newton Falls Rd., Ravenna, Ohio 44266.

* Beans, like wheat, in many communities can be purchased from local farmers' co-ops or local stores at much lower delivered cost than from mail order firms. In one small Colorado town the co-op sold 25 pounds of pinto beans in a polyethylene bag for \$1 1.25-45 cents a pound. Local supermarkets sell bulk pinto beans for around 60 cents a pound.

* Non-fat milk powder in 1990 is sold nationwide in the larger cardboard packages for around \$2.85 per pound. A better buy for multi-year storage is the instant non-fat milk powder sold by Preparedness Products. This Mormon-owned firm's 1990 FOB price is \$57.95 for a case of 6 nitrogen-packed cans, containing a total of 22.5 pounds. The author bought a case three years ago and found this non-fat instant milk powder to be excellent. At \$2.58 a pound, plus UPS shipping charges, the cost is considerably less than for comparable milk powder packaged for multi-year storage and sold by other companies.

* Vegetable oil, sugar, salt, and multi-vitamin tablets are best bought at discount supermarkets. In cities such stores often sell large plastic containers of vegetable oil as "loss leaders" to attract customers, at prices as low as wholesale. Vegetable oil prices in small communities typically are much higher. For an economical survival ration, buy the lowest priced vegetable oil. Remember that one of the worst post-attack nutritional deficiencies will result from chronic shortages of fats (including oils), and that babies and little children cannot survive for a year on a diet of only grains and beans, with no oil or fat. See the Food chapter.

° CAUTIONS: Typical health food stores and most firms that specialize in survival foods sell basic foods at high prices, especially grains, beans, and milk powder. Investigate several other sources before buying. To make sure that an advertised "one year supply" of survival foods actually will keep an adult well nourished for a whole year, require the seller to inform you by mail what his "one year supply" provides a typical adult male in: (1) calories, kcal; (2) protein, g; and (3) fat, g. Then you can use the values in the "Emergency Recommendations" column in Table 9.1 on page 84 to determine whether the advertised "one year supply" is adequate.

° Transitional foods: The emotional shock of suddenly being forced by war to occupy your shelter will be even worse if you have to adapt suddenly to an unaccustomed diet. It would be a good idea to occasionally practice eating only your survival rations for a day or two, and to store in your shelter a two week supply of canned and dry foods similar to those your family normally eats. Then it will be easier if war forces you to make the changeover. Of course the transitional foods that you store should be rotated and replaced as needed, depending on their shelf lives.

◦ A hand-cranked grain mill: Whole kernel grains and soybeans must be processed into meal or flour for satisfactory use as principal components of a diet. If unprepared America suffers a nuclear attack, unplanned, local food reserves and/or famine relief shipments will consist mostly of unprocessed wheat, corn, and soybeans. Then a family with a manual grain mill will have a survival advantage and will be a neighborhood asset. Many health food stores at least have sources of hand-cranked grain mills. Mills with steel grinding plates are more efficient and less expensive than "stone" mills. A mail order firm that still sells hand-cranked grain mills which are efficient is Moses Kountry Health Foods, 7115 W. 4th N.W., Albuquerque, New Mexico 87107. It sells a serviceable Polish mill (Model "OB" Hand Grain Mill) for \$35.73 FOB, plus UPS shipping charges. This mill cranks easily and grinds wheat into coarse meal or fine flour more efficiently than any of the American manual grain mills. Apparently manual grain mills no longer are manufactured in the U.S. Before buying a grain mill be sure to learn whether it grinds corn, our largest food reserve

COOKING AND HEATING

◦ Safety precautions: The first rule for safe cooking and/or heating in a shelter is to do it as near as practical to the exhaust opening. If the fire is under an exhaust pipe, install a hood over the fire. Operate the shelter ventilating pump when cooking, unless a natural airflow out through the exhaust opening can be observed or felt. Keep flammable materials, especially clothing, well away from any open fire.

◦ Hazardous fuels: Charcoal is the most hazardous fuel to burn in confined spaces, because it gives off much carbon monoxide. In a crowded shelter there are obvious dangers in using the efficient little stoves carried by backpackers and in storing their easily vaporized and ignited fuels.

◦ "Canned heat": These convenient fuels are expensive. Sterno, widely used to heat small quantities of food and drink, typically retails in 7-ounce cans for what amounts to about \$9.00 per pound.

◦ Wood: The safest fuel to burn in a shelter is wood, the most widely available and cheapest fuel. Furthermore, wood smoke is irritating enough to usually alert shelter occupants to sometimes accompanying carbon monoxide dangers. Scrap lumber cut into short lengths, made into bundles and stored in plastic bags, occupies minimum space and stays dry. Keep a saw and a hatchet in your shelter.

◦ Bucket Stove: The most efficient, practical and safe stove with which to cook or heat for weeks or months in a family shelter is a Bucket Stove, that burns either small pieces of wood or small "sticks" of twisted newspaper. Especially if you believe that you may have to live in your shelter for months or that your normal fuel will not be available after a nuclear attack, you should make and store at least two Bucket Stoves.

◦ An improved Fireless Cooker: To save a great deal of fuel and time, particularly with slow-cooking grains and beans, make a very well insulated Fireless Cooker similar to the expedient one described on page 82 of the Food chapter. Make a plywood box, first measuring carefully to insure that, when completely lined with 4 inches of styrofoam, the styrofoam will fit closely around a large, lidded pot wrapped in a bath towel. An excellent Fireless Cooker is a war survival asset that also is useful for peacetime cooking. (To boil about twice as much wheat flour-meal in a given pot as can be boiled when making wheat mush, and to use the minimum amount of water and fuel, salt a batch of the flour-meal, add enough water while working it to make a stiff dough, then make dough balls about 1-1/2 inches in diameter, and roll them in flour-meal. Drop the wheat balls into enough boiling water to cover them, and boil at a rolling boil for 10 minutes. Then put the boiling-hot pot in a well insulated Fireless Cooker for several hours. Corn balls can be made and boiled in this manner, also without the almost constant stirring required when boiling a mush made of home-ground flour-meal.)

◦ A sturdy work bench: In the corner under the emergency exit build a work bench, secured to a wall, on which to cook and to which you can attach your grain mill. A bench 36 inches high, 42 inches wide, and 30 inches deep will serve. (The other corner at the air-exhaust end of the shelter should be the curtained-off toilet and bathing area.)

° Very warm clothing, footwear, and bedding: Heating a well ventilated shelter usually is unnecessary even in freezing weather if the occupants have these essentials for living in the cold, or if they have the materials needed to make at least as good expedient means for retaining body heat. If you store plenty of strong thread and large needles in your shelter, you can make warm clothing out of blankets - as some frontier settlers did to survive the subzero winters of Montana. Building costs

OTHER SHELTER NEEDS

Store enough soap to last your family for at least a year. After a major nuclear attack the edible fats and oils, used in past generations to make soap, will almost all be eaten. Production of detergents is based on inter-dependent, vulnerable chemical industries not likely to be restored for years. A chemical toilet would help bridge the gap between modern living and surviving in a crowded shelter. For months-long occupancy, however, a more practical toilet is likely to be a 5-gallon can with a seat, a plastic trash bag for its removable liner, a piece of plastic film for its tie-on cover, and a hose to vent gasses to the outdoors. Store at least 200 large plastic trash bags. Using anything other than paper in place of toilet paper or cloth is hard to get accustomed to. A hundred pounds of newspaper, stored in plastic trash bags to prevent it from getting damp, takes up only about 3 cubic feet of storage space and would be useful for many purposes. Keep several thousand matches, in Mason jars, so that they will be sure to stay dry even if your shelter becomes very humid post-attack.

Store most of your radiation monitoring instruments in your shelter, along with paper and pencils with which to keep records of radiation exposures, etc. A steel or reinforced concrete shelter should have a transistor radio with extra batteries, and a vertical pipe through which an antenna can be run up to improve reception.

CONSTRUCTION PHASE

Foundation Layout

First you must be the owner of the property intended for the fallout shelter. Please check the deed to the property to make sure you are not over stepping your boundaries. You are going to be digging a deep hole in your yard. Make sure you know where you are digging. Please call your local utilities to make sure you are not digging up a gas main. Again I will say it one more time **Please do your homework a head of time before you dig.**

Regardless of the foundation size you select, the first step is to prepare the site and lay out the under ground building lines. Site preparation consists of simply clearing the site of all woody vegetation, making sure it is fairly level and removing large rocks. If there is any doubt about the water table and drainage at the site, dig a test pit to see what kind of soils you'll be building in and how well drained they are. An Extension Service agent can help you analyze your soils and their suitability for building.

Once you have figured out roughly where your shelter will reside and the dimensions of the shelter, you can lay out the exact building lines for the excavation work. Keep in mind that careful layout work will prevent headaches later on, Don't hurry. Laying out a underground building is relatively simple but it takes time and attention to detail. Remember, building the shelter is like building a house with a basement. The only difference is that you will not build a structure on the basement. You will be capping of the roof and burying the basement in soil. Most basements average 8 feet deep. Your shelter will start 12 feet deep below the ground.

To get started, collect four wooden stakes, perhaps 2 x 4s about 2 feet long, and obtain a 50- or 100-foot steel measuring tape. One stake with a nail in its top will be located at each corner of the underground building, to indicate the outside line of the foundation walls. First, measure one long wall of the underground building and drive two stakes into the ground, one at each corner (or end) of the wall. (Align the wall according to your site plan.) Drive a nail into the center of the top of each stake, at the exact corners of the wall. Extend a mason's string tautly between the two stakes and tie it to the two nails. Some builders continue the layout by measuring the remaining walls and placing stakes at the exact corners.

Then, to assure that the corners are square, they measure the long diagonals to see if they are the same length. However, there's another way to proceed:

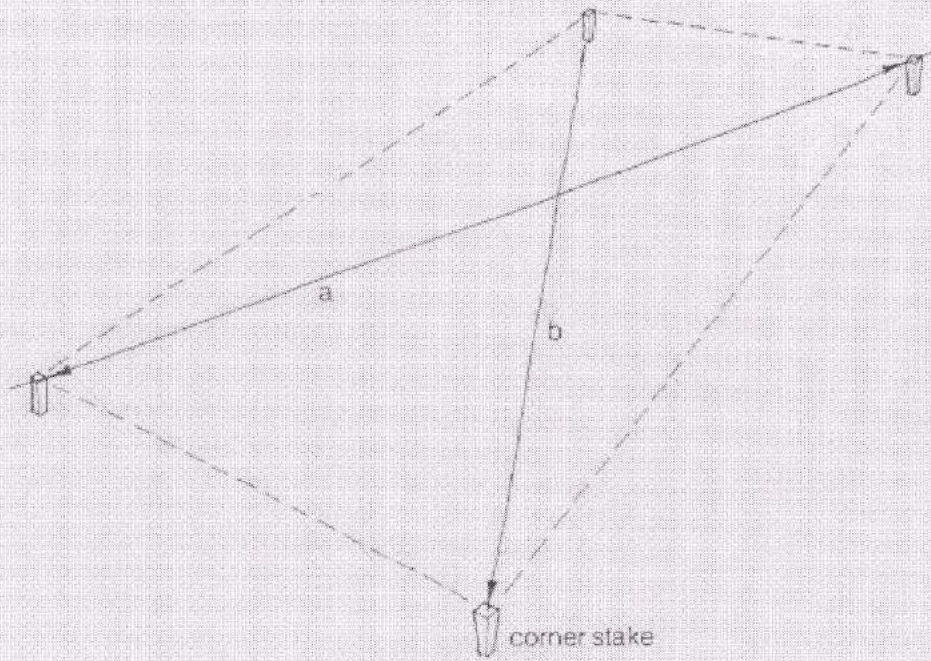

One way to check the squareness of a foundation layout is to assure that the diagonals (a and b) are equal.

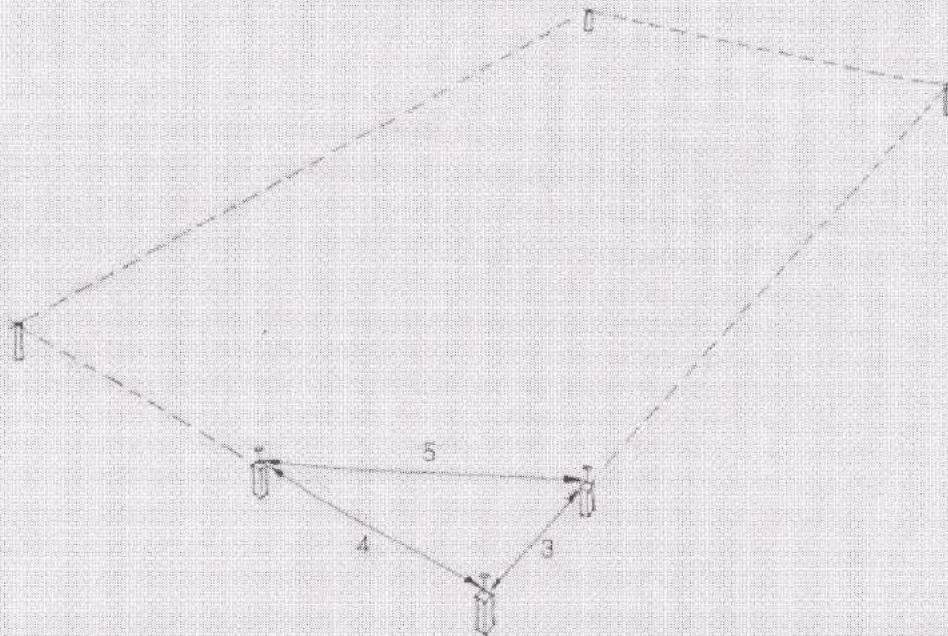

Or, you can use the 3-4-5 triangle method.

To layout an adjoining wall and square it with the first, you can use the triangle rule. The rule is that any triangle that has sides with 3 feet, 4 feet and 5 feet (or multiples thereof) will make up a right-angle triangle. The square corner will be where the 3- and 4-foot sides meet. When using this method, it's important to use the appropriate maximum expansion of the 3-4-5 rule to fit the underground building. To establish a 3-4-5 triangle and thereby ensure that a second wall is perpendicular to the first, follow the steps outlined in the accompanying box

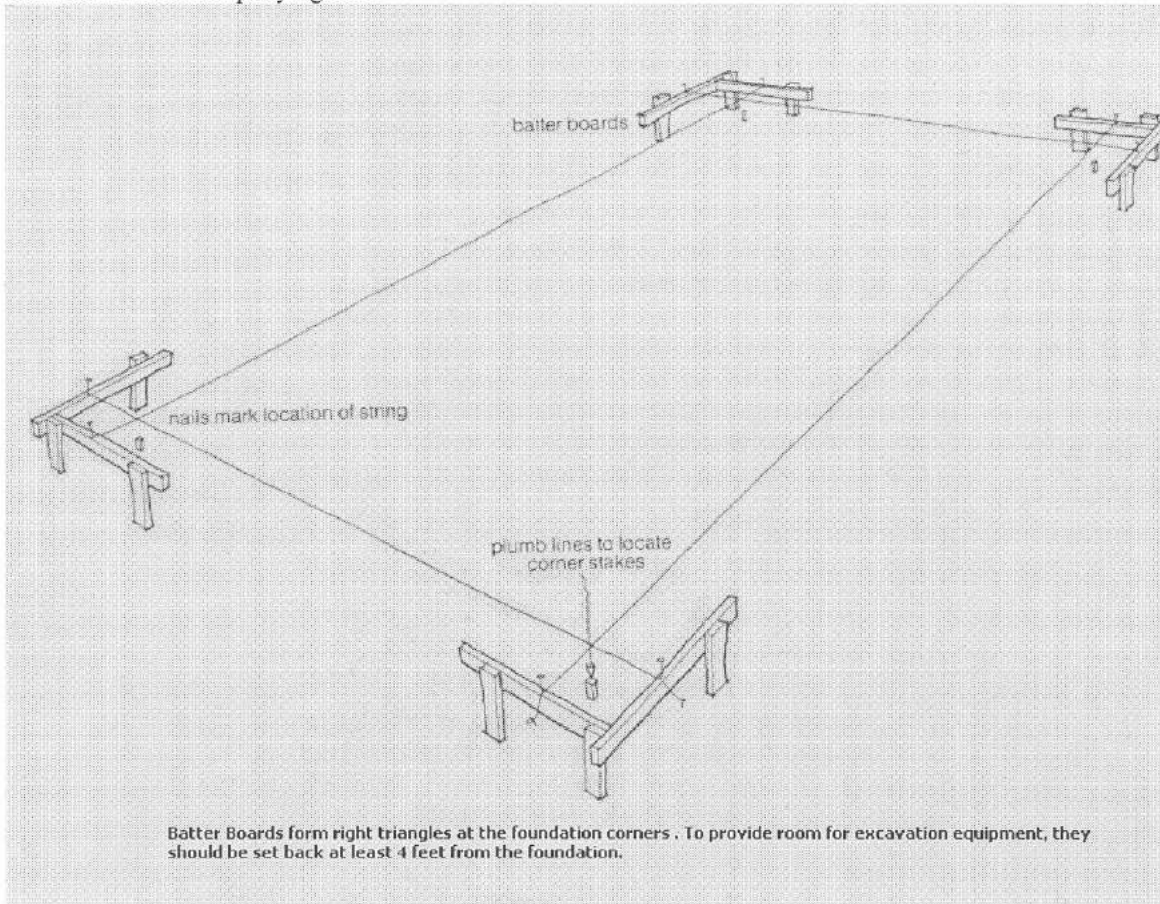

1. Go to one corner, measure down the string 3 feet (or multiples thereof), drive a stake into the ground and, at exactly 3 feet, pound a nail into the top of the stake.
2. Ask a friend to take another string (or measuring tape if you have one), attach it to the corner stake and measure 4 feet. Mark at that length. Extend the string or tape in the direction of the adjoining wall.
3. Hook a measuring tape over the nail on the stake set at 3 feet. Extend the tape 5 feet toward the adjoining wall.
4. When the 5-foot and 4-foot points intersect, a right-angle triangle is formed and the corner is square. At the point of intersection, drive another stake. This establishes a line for the building's adjoining short wall and makes it square with the long wall.
5. Once the right-angle triangle is formed, extend the string or a tape beyond the 4-foot point, as necessary, to reach the full dimension of the wall. If you're planning on a side wall of 20 feet, for example, extend the string to that distance. Again, drive a stake into the ground at the new corner, and pound a nail into the stake at the exact wall dimension.
6. Repeat steps 1 through 5 until foundation outline is complete. If you anticipate laying out several foundations, you might make a permanent 3-4-5 triangle from scrap wood to facilitate layout of the corners.

Now that the outside corners of the underground building are marked exactly with stakes, it is time to set the batter boards. Batter boards are simply short boards nailed to 2- to 3-foot long stakes to form a right-angle corner. The purpose of batter boards is to hold the building lines and to keep their location marked while the foundation trenches or holes are excavated. Locate the batter boards at least 5 feet outside the building corners so that a backhoe can dig a trench without disturbing them.

Attach a new set of strings to the batter boards so that they cross exactly on top of the corner stakes. The position of the strings on the batter boards can be marked with nails securely driven into the tops of the boards. The strings can now be removed and the corner stakes taken up in order to excavate the foundation. If you need to find the exact building line again during excavation, you can quickly reattach the strings to the batter boards.

As you lay out your underground shelter, keep in mind what the string line really marks. It should mark the *outside* edge of the foundation wall, not their center or inner edge. This is very important.

Excavation

Excavating can either be done by hand or by a backhoe. Your shelter will have a deep wall foundation and you may encounter rocky soil. If this is the case, you'll probably want to hire a backhoe. A backhoe may cost \$25 an hour, but in four hours it can do more digging than you can do in a week. And if you run into large boulders, you must have power equipment.

You will be digging a deep foundation, ask the back hoe operator to keep the topsoil separate from the lower horizons as much as possible. This topsoil can then be set aside for the final grading and landscaping, and you won't have to try to grow grass in gravel or clay. Always be present when the backhoe is digging to make sure the trench is deep enough and to handle surprise problems such as coming across an old water line. The foundation depth from surface to bottom of footing should be close to 13 feet. Make sure you shore up around the foundation site to prevent any soil collapsing.



Your underground shelter will be supporting any where between 2 ½ and 4 feet of soil on the top , it is wise to rough check the bearing strength of the soils and footings to make sure they can support the entire load. Accompanying tables give the customary loads of a typical building and the bearing strength of different soils. These tables can be used to get a rough estimate of the total building weight and therefore its bearing weight per square foot of foundation area. Check this weight against the bearing strength of your particular soil to make sure the foundation footings are adequate.

HARD ROCK	UP TO 40 TONS PER SQUARE FOOT	
Soft rock	"	8 "
Coarse sand	"	4 "
Hard, dry clay	"	3 "
Fine clay sand	"	2 "
Soft clay	"	1 "

Once you have excavated your foundation trenches or holes to the proper depth, re-attach your layout strings that mark the edge of the shelter. Use a plumb bob to drop a vertical line from the string to the bottom of the trench. This is the outside of your foundation wall or 4 inches from the center of the footings if you are using an 8-inch wall. Using the plumb bob, mark 4 inches to the outside and 12 inches to the inside. The footing will go in this 16-inch space.

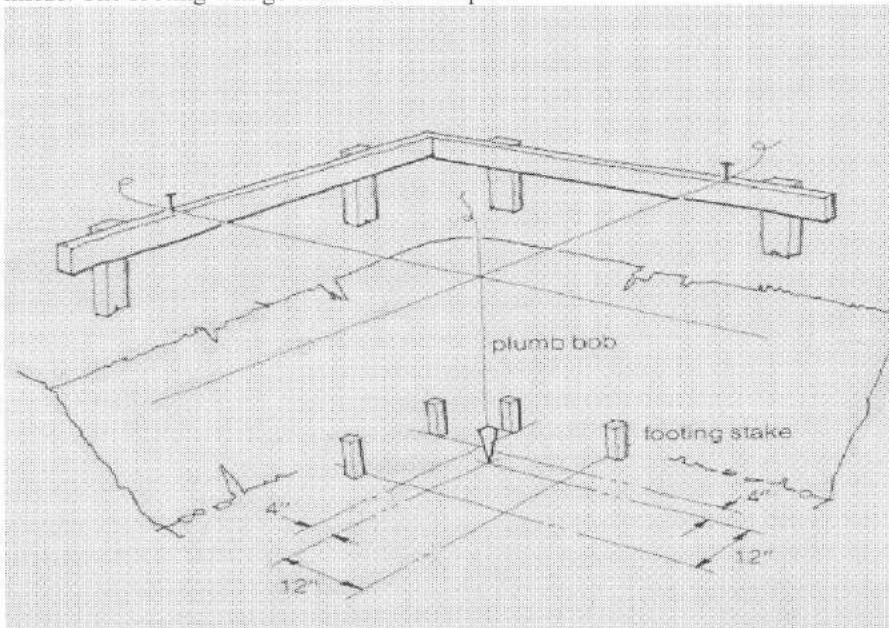

Mark the inside and outside of the footings at each of the shelter corners with stakes and attach two sets of strings to outline the perimeter of the footing. You can now build footing forms to hold the concrete in place using 2 x 8 lumber secured with stakes in the ground. Make sure the stakes are on the outside of the boards, that the boards are 16 inches apart and that their tops are perfectly level. If you need to raise the boards off the ground a bit to level them, you can simply backfill with a little dirt to seal cracks on the bottom where concrete might seep out.

In this stage of the construction, make sure you have planned the location of any underground utilities. Are you going to run a water line? How about underground conduits that will carry power lines from an electricity source. Perhaps plan on a small solar or wind farm that will feed the shelter with power. Before your walls are poured or build with blocks, make sure the plumbing, venting, and electrical is laid out and complete. You do not want to be drilling through the new walls that were just erected.

Footings

Footings are the fundamental building supports carrying the foundation wall. For your under ground shelter, they will be twice the width of the foundation wall and one half as thick. Thus for a normal 8-inch foundation, the footings should be 16 inches wide and 8 inches thick.

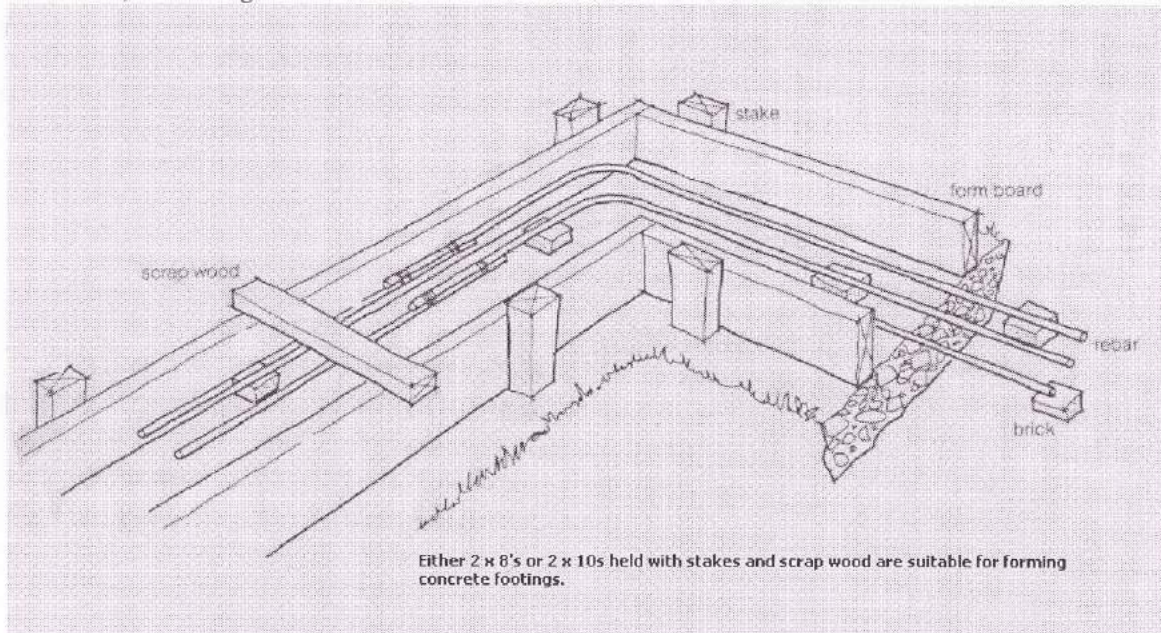

When you pour footings, make absolutely sure they are on solid, undisturbed ground that has been scraped free of all loose dirt. Footings poured on loose dirt will later settle causing the foundation and the building to settle and sometimes crack. If for some reason, the soil beneath the footings has been disturbed, be sure to tamp it down thoroughly. $\frac{1}{2}$ " rebar is placed in the footing form before the footing is poured with concrete. Rebar helps increase the compressive strength of the concrete. Use small blocks of brick to support the rebar in the form. The rebar should be 3" above the ground surface and spaced about 8" apart in the form. If you decide to order concrete from a batch plant, order 4000psi test.

When putting in a foundation, you must first decide whether to mix the concrete by hand or have ready-mix concrete delivered by truck. Your decision will be based on the cost of ready mix concrete, the size of the job and whether you can get a concrete truck to the shelter site. Excluding labor, ready-mix concrete is quite a bit more expensive than concrete you can mix by hand in a wheelbarrow or machine mix in a power mixer. In general, however, for Jobs that require a continuous pour of 1 cubic yard or more, buying ready-mix concrete is the right choice. A concrete truck with chutes can back right up to your foundation, deliver the concrete exactly where you want it and pour your footing in minutes.

Usually, $\frac{1}{2}$ to 1 cubic yard is the minimum load a concrete supplier will deliver, and you should establish beforehand what truck charges or minimum load charges you will be billed for. (The maximum load one truck can usually carry is 5 yards.) Everything should be in place and set to go before the truck arrives. Normally, you have one hour to unload the truck and after that a substantial hourly truck fee is charged. Also, the concrete may set up quickly so make sure the forms are securely in place, that the truck can reach all sections of the foundation with a 10-foot chute, and that you have shovels and a wheelbarrow handy in case you have to transport concrete by hand to a far corner.

Concrete for individual footings or small foundations can be mixed by hand in a wheelbarrow or power mixer. Never use a wheelbarrow to mix more than 1 cubic yard. A good-sized wheelbarrow will hold only about $1 \frac{1}{2}$ cubic feet of concrete, meaning you'll need to mix about 20 wheelbarrows full before you get 1 cubic yard. For small jobs such as pouring pier footings, however, a wheelbarrow and pre-mixed bags of

concrete are fine. Pre-mixed concrete is available in 80-pound bags; each bag makes about 2/3 of a cubic foot of concrete. One bag of concrete mix is just right for a 16-inch diameter footing, 6 inches thick.

If you're mixing more than a yard of concrete, get either an electric power mixer or one that can be driven from a tractor power take off (PTO), and buy the concrete ingredients in bulk. Concrete is a combination of Portland cement, sand and gravel mixed with water. The standard mixture usually specified for foundations is 1:2 1/2:3 1/2, or 1 part Portland cement, 2 1/2 parts sand and 3 1/2 parts gravel. If the sand is damp (and bulked up), use a 1:2:4 mixture.

The sand and gravel should be clean and free of trash, leaves and other debris. Also, it should be screened to remove small pebbles and to assure uniform size. Gravel or crushed stone can be obtained from concrete suppliers, sand and gravel dealers or building supply companies.

Because the size of gravel or crushed stone varies in different locations, it may be necessary to change the amount of cement in your mix. Generally speaking, when gravel is smaller than the normal 1 1/2-inch size, it is good practice to use more cement. When gravel size is a maximum of 1 inch, add 1/4 bag of cement to a five-bag mix; when gravel is a maximum of 1/4-inch, add 1/2 bag.

When mixing concrete, first place the cement, sand and gravel in the wheelbarrow or mixer and mix thoroughly. An old hoe with a couple of holes cut in it and a shortened handle makes an excellent tool for mixing small amounts. When the aggregates and cement are mixed thoroughly, and no dark or light streaks remain, add water. The amount of water is *very* important and ultimately determines the strength of the concrete. Too much water makes the finish concrete weak and flakey. Too little and the solution may not mix properly, or it may set up too quickly. Usually, you should add five gallons of water for each 94-pound bag of cement. If the sand is wet, use less.

Don't add the water all at once. Add just a little at a time and allow the concrete to mix thoroughly, then add more as needed. To test the mix to see if it has the right amount of water, pull the hoe through the concrete in a series of jabbing motions. If the mix is correct, the little ridges pulled up will stay. If it is too wet, the concrete will slump back quickly. Add more gravel and cement. If the mix is too dry, the ridges won't be smooth and even.

Working With Concrete

When working with concrete, always wear rubber gloves and rubber boots. Rubber gloves will protect your hands from the abrasive and caustic action of cement which can easily wear away skin after a few hours of contact. Rubber boots will allow you to step in the concrete, water and mud without getting wet, and your good leather work boots won't be ruined. When pouring your footings for your shelter, the forms must be used to keep the concrete in place. As I mentioned earlier, 2 x 8 boards held in place with stakes are fine for footings. Concrete must harden or "cure" before forms are removed or weight is put upon it. Within 24 hours of pouring, concrete will be hard enough to take off the form boards in order to start waterproofing and backfilling the foundation. However, the concrete is still "green" and extremely susceptible to chipping or cracking. If possible, leave the form boards on three or four days and cover any exposed concrete with burlap or old bags that can be wetted down periodically. Concrete must cure and dry slowly, otherwise it will be weak and crumbly. Try to avoid pouring concrete slabs in the hot, noon sun, and always have a water hose on hand so you can dampen the surface if it starts drying too fast.

Concrete must also not be allowed to freeze. If you are pouring in the fall or winter and there is a chance of frost, insulate the concrete with a covering of old tarps and hay. In cold weather, use heated water and aggregate to make sure the concrete is warm enough to set up. Add calcium chloride to the concrete mixture if you want to lower its freezing point. Winter concrete work is best left to experience contractors, since it is easy to ruin an entire foundation if it does not cure properly.

POURED CONCRETE WALLS

Very important that when you pour your footings for solid concrete walls that you make a keyway in the center of the footing. The placement of a 2x4 is placed embedded in the concrete on the center line of the

footing. The top of the 2x4 is flush with the surface of the poured concrete. Once the footings cure the 2x4 can be taken out to form the keyway. To make life easier, coat the 2x4 with linseed oil or old crankcase oil. The task of removing the 2x4 will be much easier. Once your wall forms are complete before you pour your concrete make sure your 1/2" rebar is wired up in the center of the forms. Please reference the figure below.

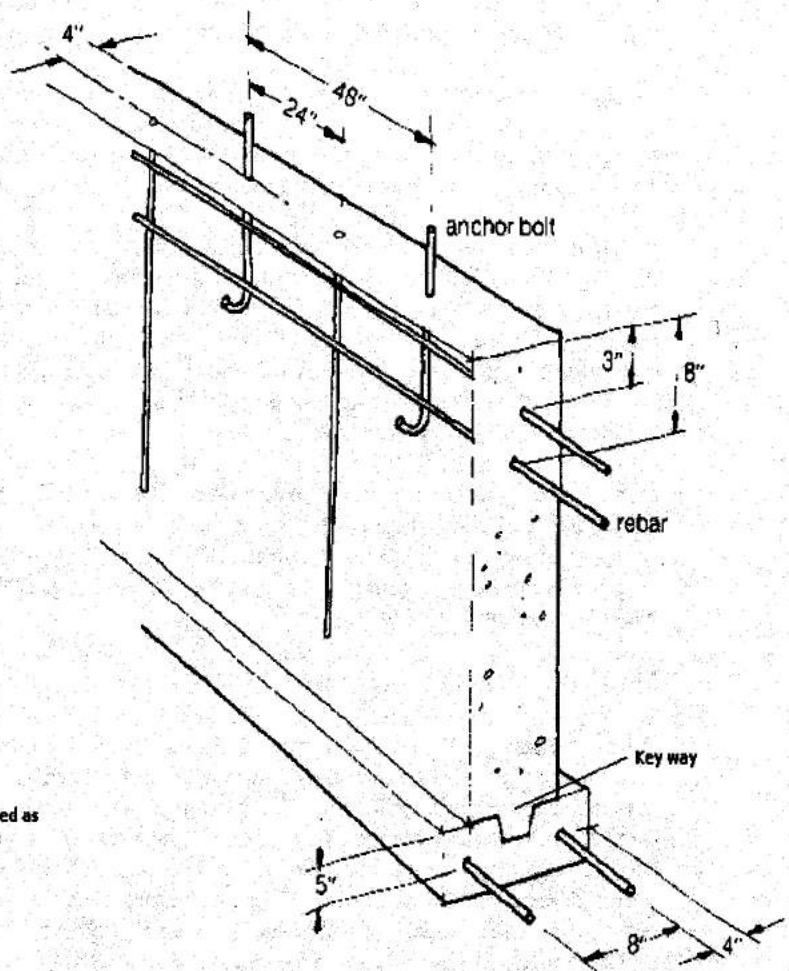

Concrete walls and footings are strengthened with rebar placed as shown here. Please note the importance of the spacing of the rebar and anchor bolts.

You can make wall forms from 1/4-inch plywood, or 1-inch boards, supported by 2 x 4 studs every 16 inches and braced at every stud. This type of form can support concrete up to 4 feet high. The plywood panels should be 8-inches apart and tied together on top with 1 x 4 boards. Again, oil the inside faces of the plywood with linseed oil or old crankcase oil before pouring the concrete. That keeps the concrete from sticking.

For your shelter you will need forms more than 4 feet high, you'll need double 2 x 4 horizontal bracing tied together with steel rods. Because these forms are complicated and expensive to build, it is often wise to rent them from a tool-rental company or concrete supplier. Standard panels are available in 4- and 8-foot heights that go together quickly with steel pins.

Many different types of wall forming systems are available. Regardless of the details of form construction and methods of erection, there are certain basic considerations that should be understood and applied to all systems. For quality work the forms used must be tight, smooth, defect-free and properly aligned. Joints between form boards or panels should be tight to prevent the loss of the cement paste which will tend to weaken the concrete and result in honeycombing. Wall forms must be strong and well braced to resist the side pressure created by the plastic concrete. This pressure increases tremendously as the height of the wall is increased. Regular concrete weighs about 150 lbs. per cu. ft. If it were immediately poured into a form 8 ft. high, it would create a pressure of about 1200 lbs. per sq. ft. along the bottom side of the form. In actual practice, this amount of pressure is reduced through compaction and hardening of the concrete and it tends to support itself. Thus, the lateral pressure will be related to the amount of concrete placed per hour, the outside temperature and the amount of mechanical vibration. Low wall forms, up to about 3 ft. in height, can be assembled from 1 in. sheathing boards or 3/4 in. plywood, supported by two-by-four studs spaced 2 ft. apart. This height is good for covered pump houses or wells.

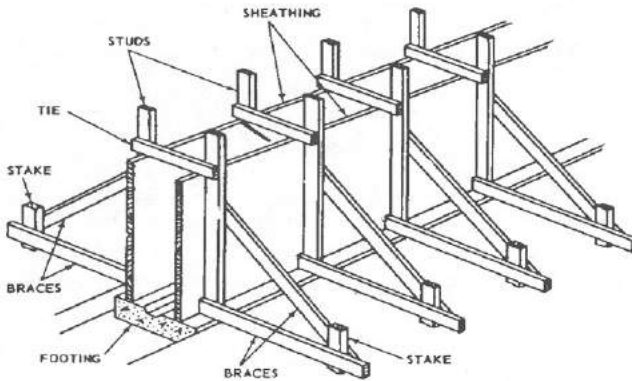

Suggested design for low wall forms -- 3 ft. or less in height.

The height can be increased somewhat if the studs are spaced closer together. For walls over 4 ft. in height, the studs should be backed with wales to provide greater strength.

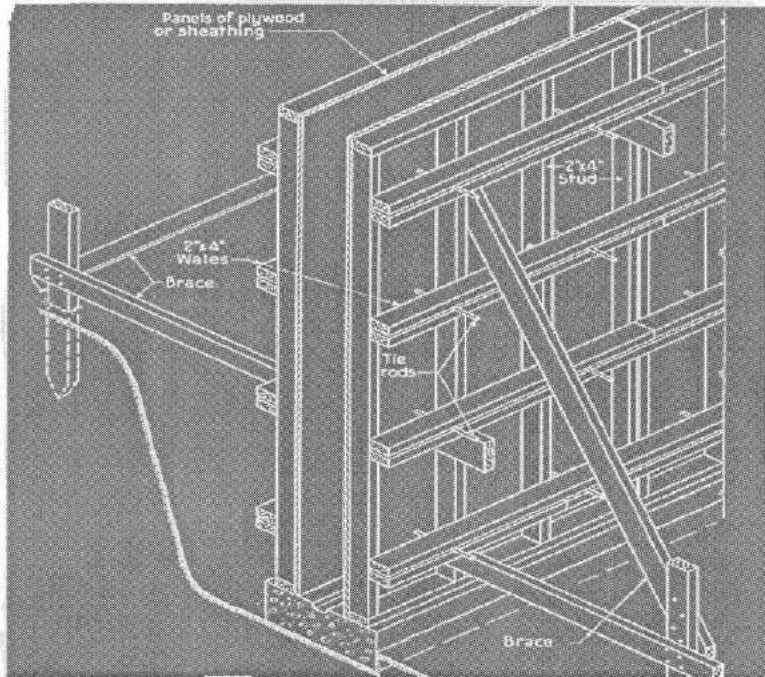

Form Ties

Wire ties and wooden spreaders formerly used have been largely replaced with various manufactured devices in which the function of the spreader and tie are combined.

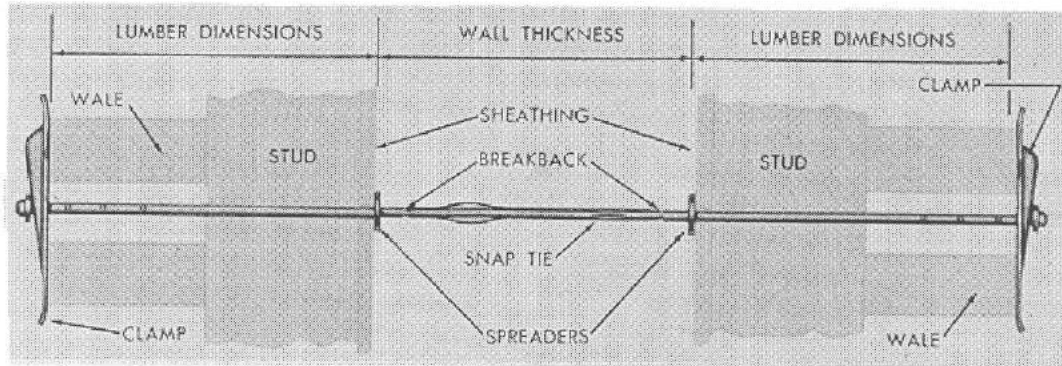

The Figure above shows a type called a snap tie. This is available for various wall thickness. The rod goes through small holes bored through the sheathing and studs. Holes through the wales can be larger for easy assembly or the wales can be doubled as shown. The spreader washer is rigidly set on the tie rod, thus holding the forms apart.

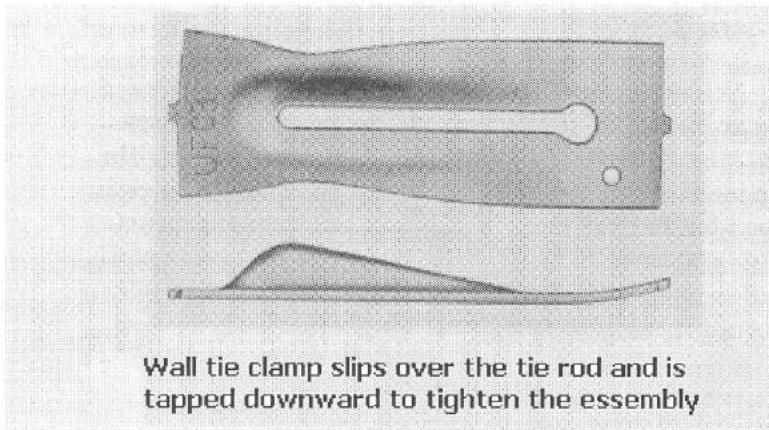

Clamps are placed over the rod and tapped down to tighten and hold the assembly together.

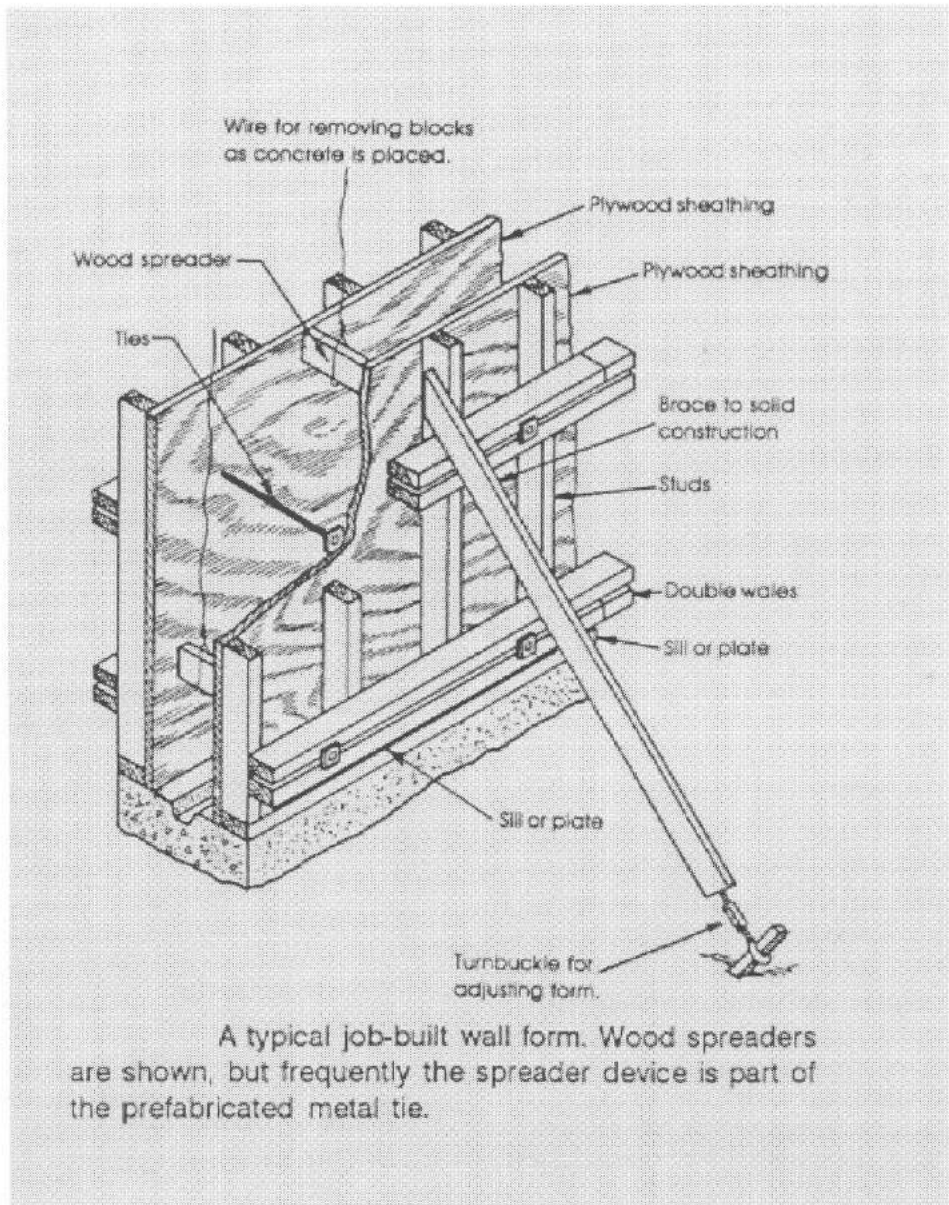

After the concrete has set, the clamps can be quickly removed and the forms stripped. A special wrench is used to break off the outer sections of the rod. The rod breaks at a small indentation located about 1 in. below the concrete surface. The hole in the concrete is patched with grout or mortar, completely embedding the remaining portion of the tie and providing a smooth surface.

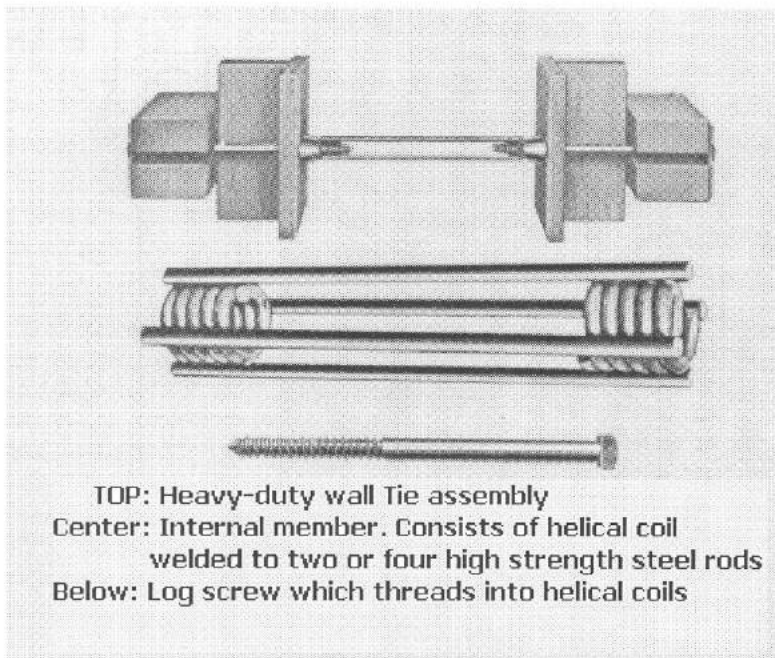

Other types of patented wall ties are shown in the above figure. The coil type spreader is assembled with a cone of wood, plastic or metal

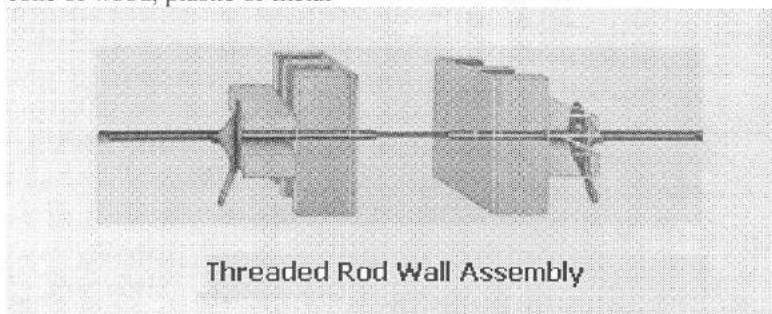

and a lag screw. The cone provides smooth contact with the form and leaves a recess that is easy to fill. The other type consists of threaded rods that attach to the center tie section and are then screwed out after the forms are stripped. Pressure is applied with either a nut-washer or a tilt lock clamp. The latter allows for rapid assembly and disassembly since the threads do not engage except when the clamp is perpendicular with the bolt.

When the concrete is ready, pour it into the forms continuously to avoid cracks, voids and weak spots. These blemishes can best be avoided by using ready-mix concrete for large building foundations. Try to pour the concrete exactly where you want it so you won't have to move it again with shovels and rakes. This will make it easier on your back and improve the concrete's strength.

Once the footing or wall forms have been filled, poke a shovel around the outside edges of the concrete to knock out air bubbles and help the concrete settle evenly. Do not overdo this and cause settling of the aggregate to the bottom.

Using a short piece of 2 x 4 or a magnesium float, strike or screed the excess concrete off the top of the forms and smooth until the concrete is level. Now move the 2 x 4 or float in a sawing motion along the top of the forms. This operation is called floating concrete; it raises the water and cement paste to the top to give a smooth finish. Do this until all the large aggregate is submerged, but don't attempt to make the top as smooth as glass.

Concrete Block Foundations

You can use concrete blocks to build your foundation walls for your shelter. They're easier to build, in some ways, and they are usually cheaper. This depends on the current price of concrete relative to concrete blocks and, if you seek help from a professional mason, the cost of this service. The greatest advantage of a block foundation is that you can build your walls as time permits. Of course you can choose poured foundation walls. Poured walls are stronger, but harder for the amateur to erect. Please refer to the section on poured wall foundations. When you construct your shelter block foundation, make the wall lengths multiples of full-sized blocks if possible. This eliminates the necessity of block cutting. The standard nominal block size is 8 x 8 x 16 inches. The actual size is 8 x 7 1/8 x 15 5/8 inches. This allows for a 1/8-inch mortar joint between blocks and between rows.

You should strengthen your block walls by cementing 1/2" reinforcing rods vertically inside the block cores or by adding galvanized hardware cloth or metal tie bars to the top of a course (horizontal layer). Always add a layer of reinforcing mesh on top of the third-to-last course to strengthen the top of the wall and to suspend the mortar for the anchor bolts. Use 18-inch anchor bolts, placed every 4 feet, for block walls. Insert them in mortar, 15 inches into the wall, so that 3 inches are left to hold the sill.

As with concrete, you can mix mortar in either a wheelbarrow or a power mixer. Type M mortar, used for foundation walls, is a mix of 1 part Portland cement, 1/4 part hydrated lime and 3 parts clean sand (80-pound bags of mortar mix are also available from building suppliers). When mixing mortar, always remember to dry mix it first, add just enough water to give it a pliable consistency, and then test it for proper stiffness with a hoe. If it is pliable, yet pulls up easily with a hoe and stays without slumping, it is mixed properly.

Laying blocks

The shelter walls including the stairwell should be constructed to the same height before the roof slab is poured. Once the roof slab is poured and cured, the stair well can be completed to grade level. Again, you will continue the stairwell using blocks or poured concrete. After completing the footings, put your building strings back on the batter boards to re-establish the outside corners of the foundation. At the point where the strings intersect, drop a plumb bob to determine the exact corners of the foundation wall.

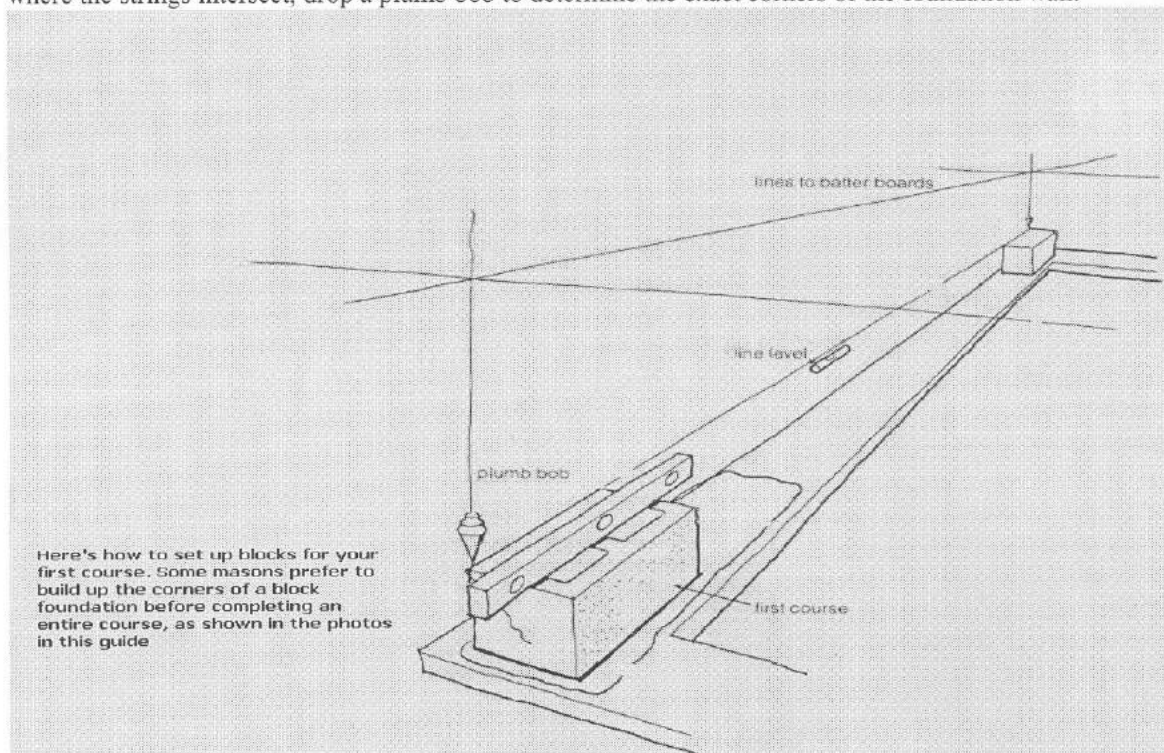

Place one block at each corner, then position strings from the top outside corner of one block to another. This will give you a straight and level line for laying the first row of blocks. Mix only enough mortar to use before it hardens (an hour or so), and begin at two of the marked corners. Trowel about 1/2 inch of mortar under the two corner blocks and, using the string and a line level, adjust them until they are straight and level with each other. After leveling the blocks, you should have a 1/8 inch mortar joint beneath each block.

Smear mortar on the end of a new block and position it against the corner block, again making sure it is level with the first block and straight along the string. Continue laying the first course in this manner. The last block may have to be cut if your joints were too thick or the wall dimensions uneven with multiples of 8 inches. If so, use a mason's hammer or brick chisel to score the block on both sides until it cracks along the desired line.

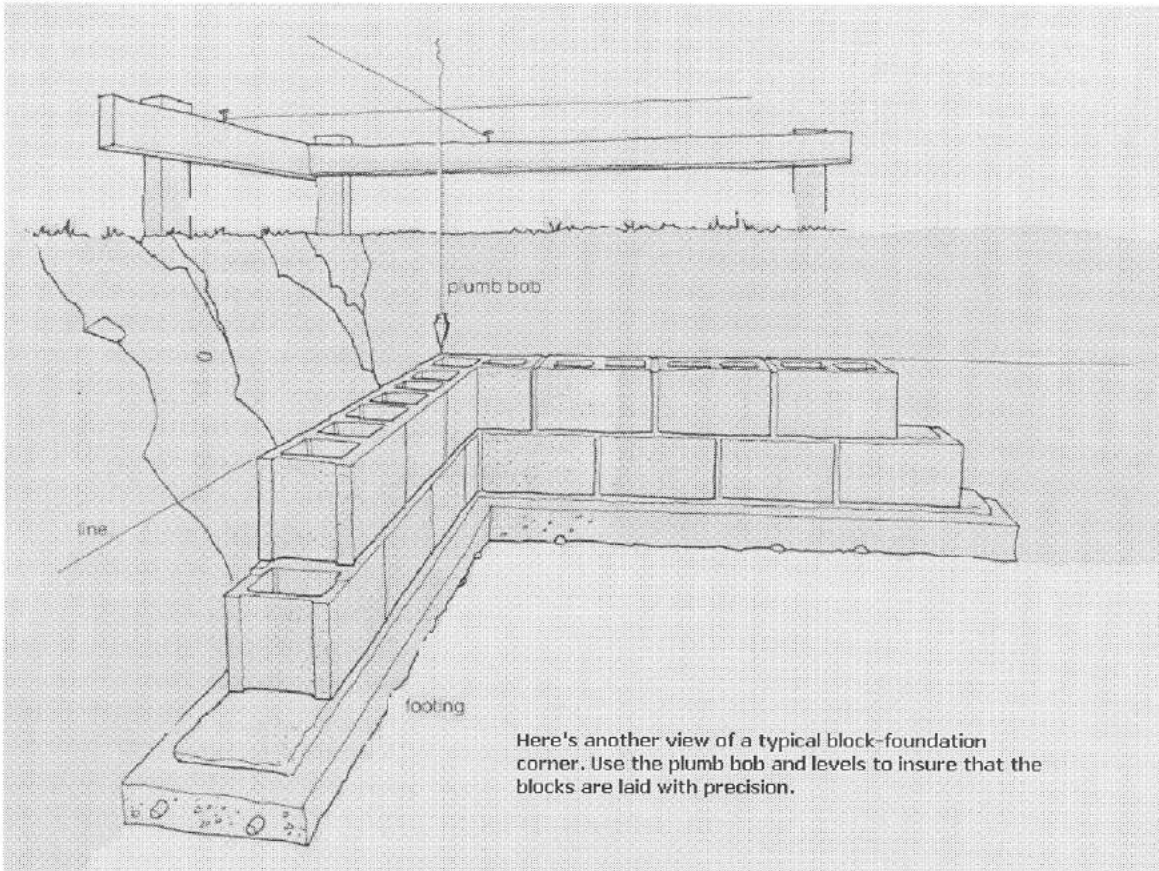

After finishing the first course, position your strings for the second course and proceed as with the first. Blocks at the corners of the walls should overlap, so that the vertical block joints do not line up. Use a carpenter's level as you build up the corners to insure they are plumb. Before the mortar dries, use the trowel to strike off excess mortar from the joints. Then smooth the mortar with a jointing tool and create concave recesses along the joint lines. This action packs the mortar joint and helps create a strong, secure wall.

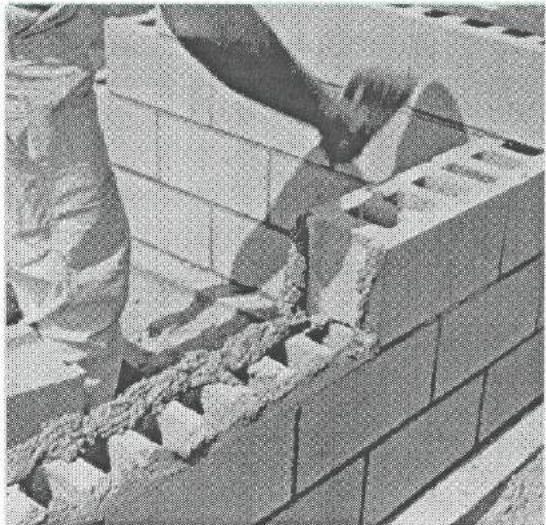
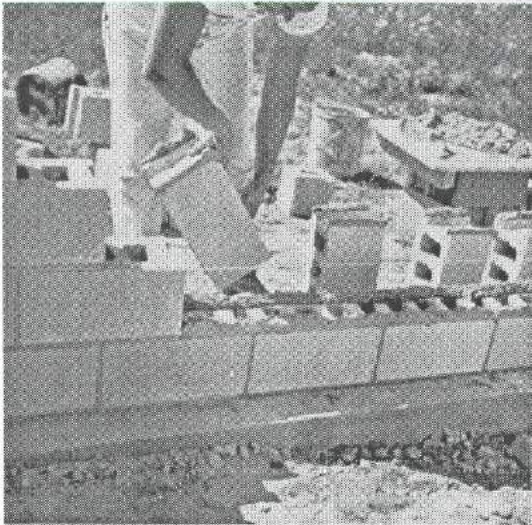
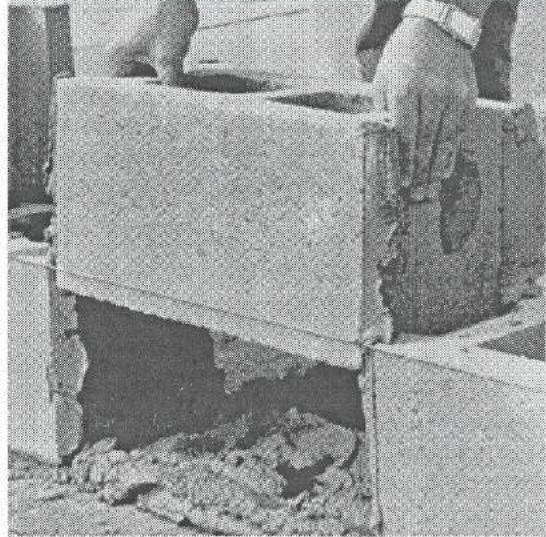

After laying a block foundation, waterproof it with mortar and tar just as poured concrete walls are. In northern climates, the walls should also be insulated, and this can be done in two ways. Either apply rigid foam to the outside of the wall or pour loose fill vermiculite insulation down the block cavities.

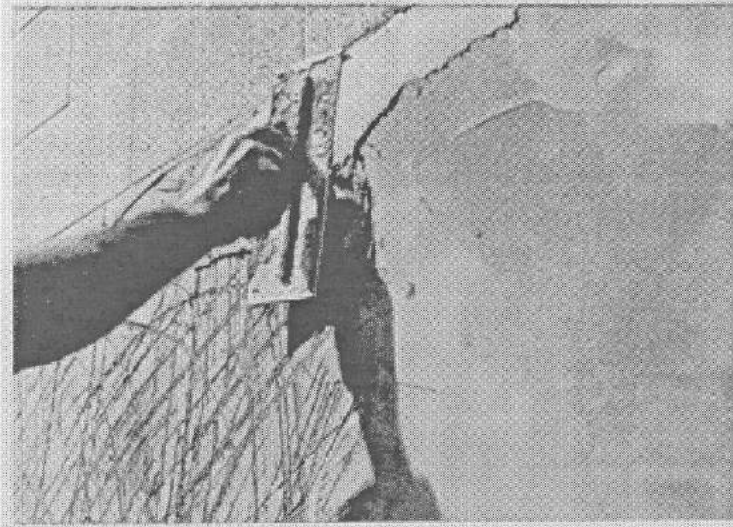



Floor Slab

Once the shelter walls are completed and cured, the floor slab can be poured in. Make sure the rebar is wired and set in the floor forms before you pour the concrete. Please reference the plans in the back. A concrete slab is finished in the same way walls are, but requires a good deal of skill and patience to get a good finish. After pouring the slab, usually to a depth of 6 inches according to the plans, use a rake to roughly level out the surface. With a helper, take a long, straight 2 x 4 and use this to screed off excess concrete and to level the surface further. Push the 2 x 4 back and forth with a sawing motion and slowly move down the slab about 1 inch per stroke.

Next, float the slab using a bull float with a long handle. Your skill in handling the float will determine the appearance of the floor. After all the surface water has disappeared and the concrete has begun to harden, drag a push broom with stiff bristles lightly over the surface to give the concrete a slightly textured surface. This is especially advisable for floors that will be wet and slippery.

If you are pouring a large concrete slab more than 10 or 12 feet wide, pour it as three separate sections so you can screed it and level it properly. First, divide the floor area into thirds using 2 x 6 form boards to hold the concrete. Secure these to stakes driven in the ground and make sure the top edges of the boards are level at exactly the height of the finished floor.

Pour the two outside sections first. Use a rake to tamp the concrete and force out any air bubbles, and then screed the concrete using the 2 x 6 forms as a guide. Float the two concrete sections and then let them harden for 24 hours before removing the forms and pouring the center section.

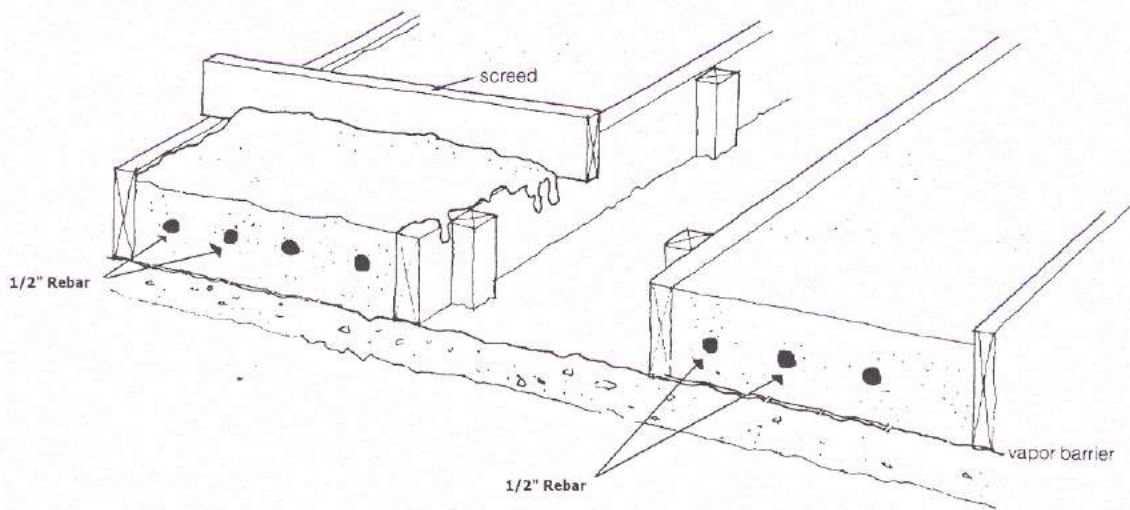

Concrete slabs must have expansion joints around their perimeter to keep them from cracking the outside foundation wall when they heat up and expand. A thin, fibrous asphalt material is available for this purpose, or you can use 1-Inch rigid foam that helps insulate as well. Large slabs should also have expansion joints every 10 to 12 feet. These can be made using a long-handled groover that forms 1 1/2-inch deep grooves in the wet concrete. After the concrete has hardened, expansion joints can also be cut with a special masonry saw and blade.

Moisture and Thermal Protection

Standing water is the downfall of many foundations. Water expands clay soils, putting tremendous pressure on foundation walls, and when it freezes, the stress is even greater. To avoid heaving and cracking, always locate foundation walls in well drained soils or install perimeter drains. In poorly-drained soils, lay plastic perforated drainage pipe around the footings after the foundation walls have been poured and tarred. Tarring with asphalt coating helps seal and protect the walls, a good way to keep water from seeping through and wetting the interior shelter space.

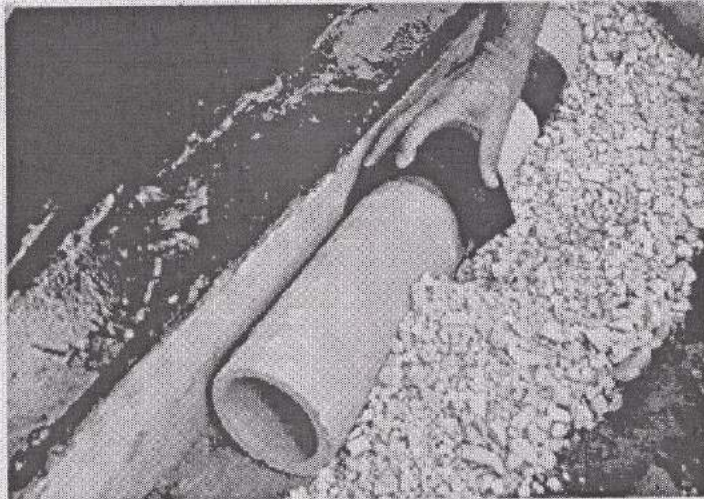
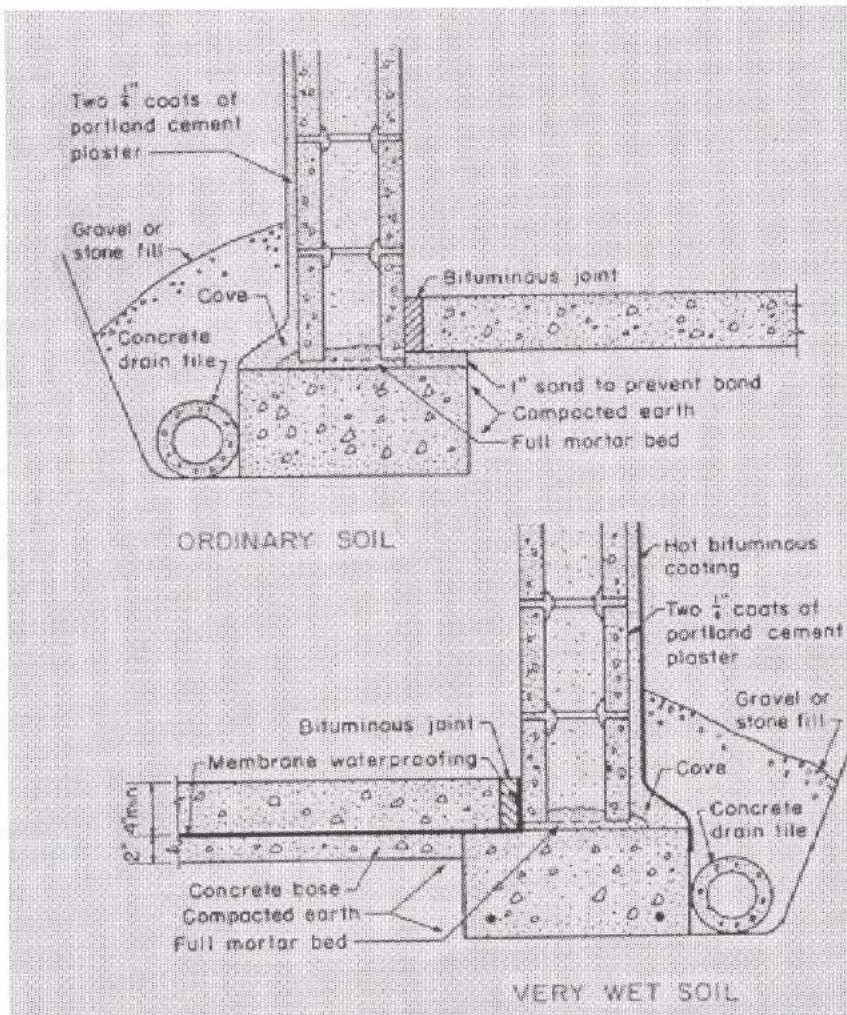

Lay the perforated drainage pipe next to the footings on at least 6 inches of clean crushed stone or pea gravel. Connect all sections of the pipe with couplings and elbows to make a continuous loop around the building. The perforated holes should face down and the loop should drain toward one corner at a minimum slope of 1 inch in 20 feet. From this corner, a discharge pipe should lead the water away from the foundation to a dry well or to a grade discharge at a lower elevation. Cover the pipes with another 6 to 8 inches of crushed stone to prevent them from clogging with mud and silt.

Insulation. Make sure you insulate the foundation of your underground shelter. Insulation reduces heat loss through it and keeps the shelter much more comfortable. Rigid foam, known as *blueboard*, is the standard foundation insulating material. Usually it is 2 inches thick and available in 2- x 8-foot sheets with a tongue and groove for a tight fit. It is applied with a concrete adhesive.

After the foundation wall has been tarred and the perimeter drains set, use adhesive to secure the blueboard to the walls, starting at the top of the footings. Install it right up to the top block.

Grading

The next step in constructing the underground shelter is to backfill the foundation trenches or holes and grade to 2 feet below the top of the shelter foundation wall. These are important steps for a long-lasting foundation. Proper backfill material and grading will keep water away from the foundation and minimize the possibility of frost cracks and heaving.

Backfilling is simply a matter of placing excavated dirt back against the foundation wall. But, do it carefully to avoid damaging the foundation or insulation. Large rocks should be placed, not thrown, against the wall. This is especially important if the concrete is still green. Use only clean fill. Wood and other organic matter will decompose and leave pockets. If drainage is a problem or you have heavy clay soils, backfill with sand or gravel to protect the wall from freeze expansion. Please refer to the picture and diagram below. To enhance drainage, make the ground slope away from the foundation. If this is impossible because of an uphill slope on one side, dig a drainage, trench two feet out from the foundation wall to catch surface water and carry it away. After the walls have been backfilled and tamped down, it's time to cap the roof. The filling in of the foundation makes it much more easier to construct the roof forms.

Roof Slab

Once the floor slab is cured, the roof can be capped off. There are several ways to construct forms for the roof. The most popular method is to build a temp ceiling flush with the top of the foundation walls made out of 4x8 plywood $\frac{3}{4}$ " thickness. You can also use the corrugated heavy sheet metal.

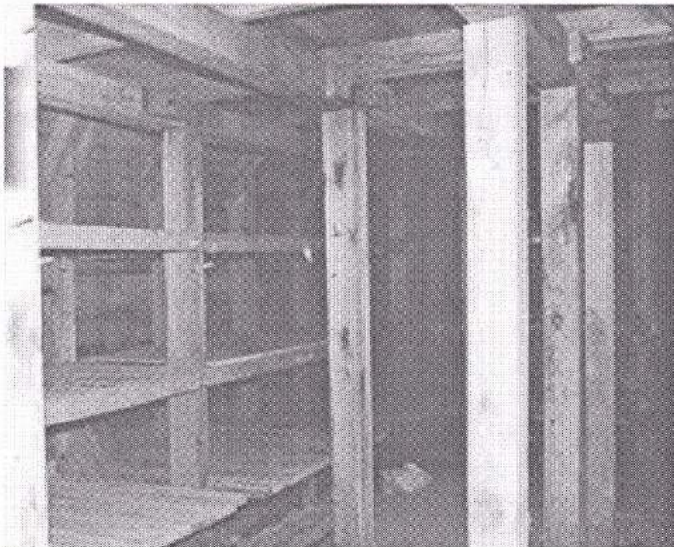

The plywood can be supported very well by rafters supported by 4x4 posts. You will be boxing the form in on top.

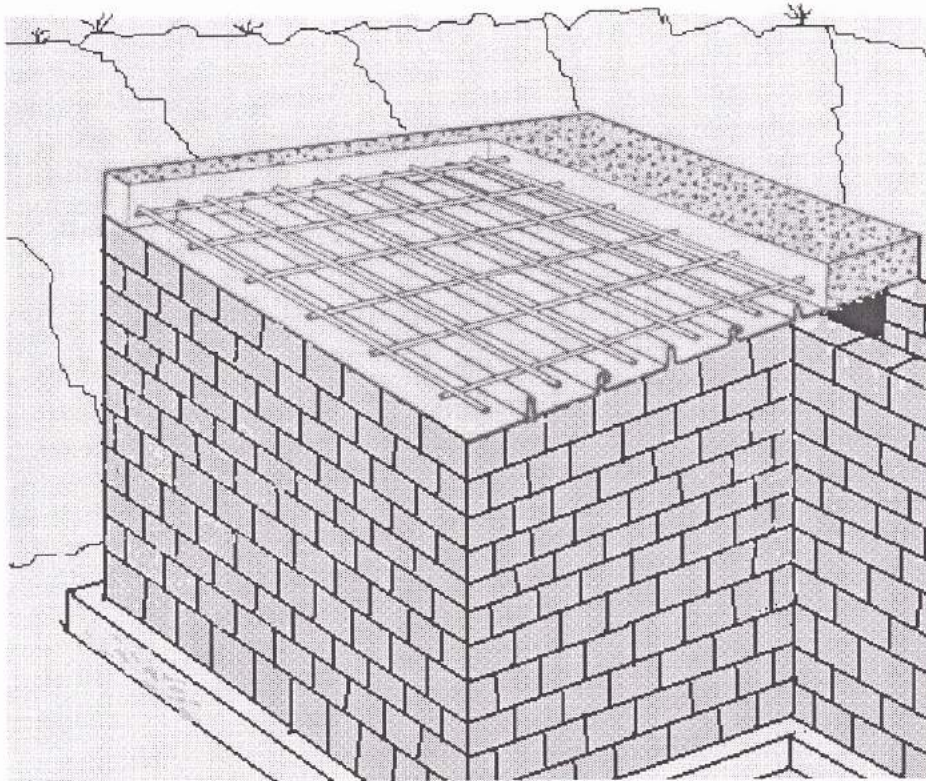

A band will be constructed around the outside perimeter of the foundation using 2x10 or 2x12 scrap lumber. The slab thickness will be 6" however the overlay will be fastened to the completed foundation wall to hold in the concrete in the liquid state. Make sure that you brace the band with 2x4's securely staked to the ground.

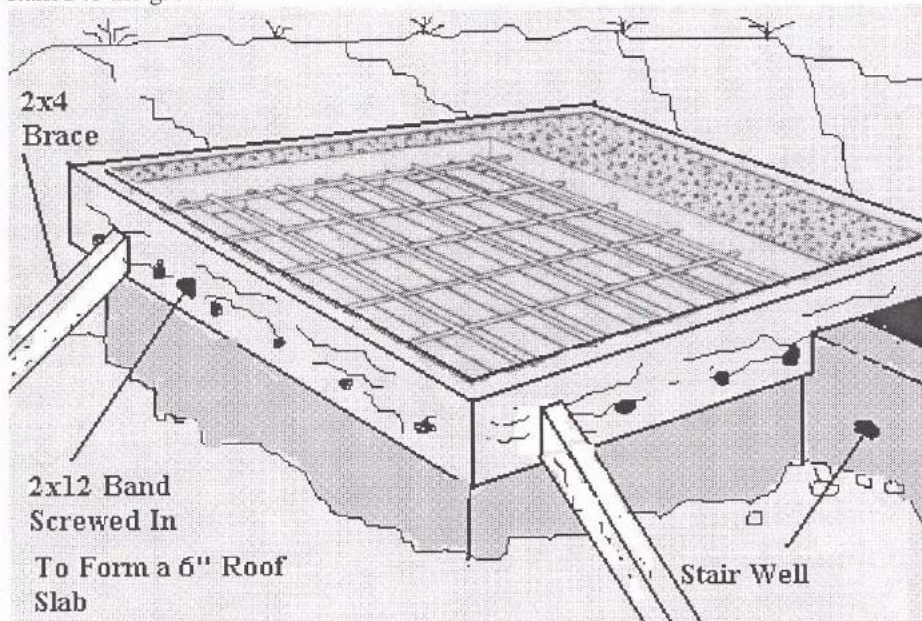

Again, the filling in of the foundation makes it much more easier to construct the roof forms. When the ceiling plywood and rafter support is completed along with the band, you wire and place the $\frac{1}{2}$ " rebar over laying vertical and horizontal spaced according to the plans, in the form box similar to the floor slab. Please reference the plans in the back. Make sure you have your roof vent pipes and any other conduit built through the roof form box before you pour the concrete. When the concrete cures on top, the form plywood

and rafters can come down. If you are pouring the roof slab over a cinderblock foundation, make sure the block holes are filled with mortar. This way your roof slab will be much more uniform. The anchor bolts should be protruding out of the roof slab. Make sure you bolt the roof slab to the foundation once cured. This prevents the roof from moving off the foundation over time from soil and earth pressures. The stairwell to grade can now be completed. The final grading can be achieved once the stairwell is complete. The staircase can now be installed along with the entrance hatch.

"Curing" Concrete

Concrete must harden or "cure" before forms are removed or weight is put upon it. Within 24 hours of pouring, concrete will be hard enough to take off the form boards in order to start waterproofing and backfilling the foundation. However, the concrete is still "green" and extremely susceptible to chipping or cracking. If possible, leave the form boards on three or four days and cover any exposed concrete with burlap or old bags that can be wetted down periodically. Concrete must cure and dry slowly, otherwise it will be weak and crumbly. Try to avoid pouring concrete slabs in the hot, noon sun, and always have a water hose on hand so you can dampen the surface if it starts drying too fast. Concrete must also not be allowed to freeze. If you are pouring in the fall or winter and there is a chance of frost, insulate the concrete with a covering of old tarps and hay. In cold weather, use heated water and aggregate to make sure the concrete stays warm.

The final product

During the final grading, use the topsoil that was set aside during excavation. Spread it evenly, seed it to grass and cover it with a thick layer of hay mulch to prevent soil erosion. The grass will grow through the mulch. Just remember you will be burying the underground shelter except for the entranceway.

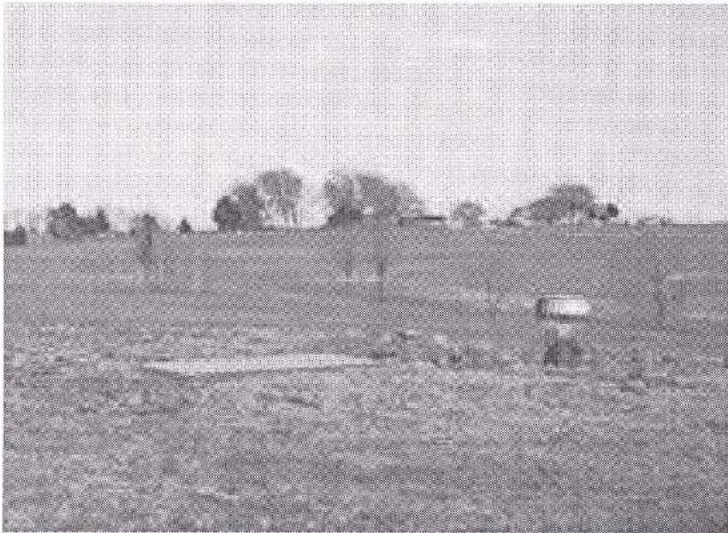

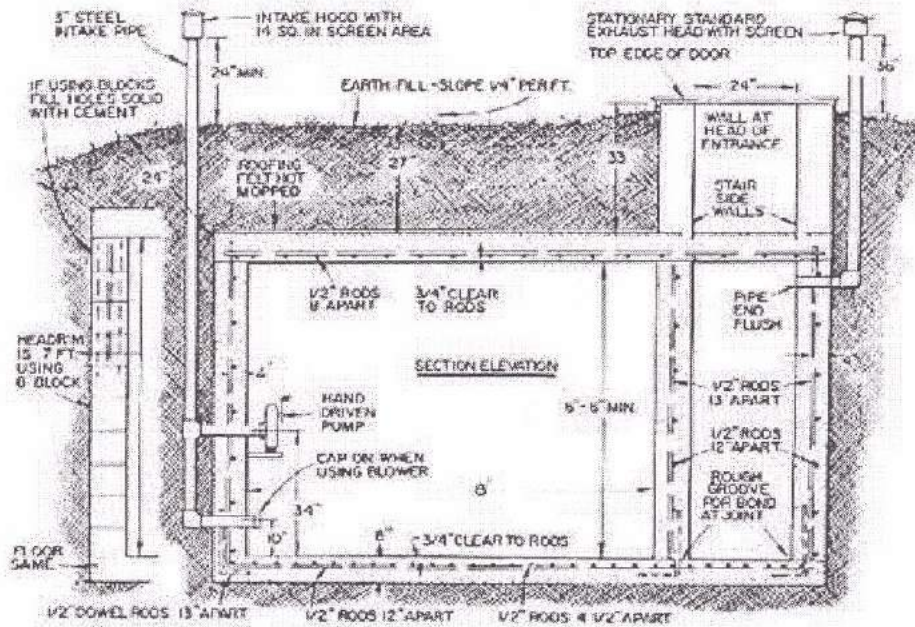
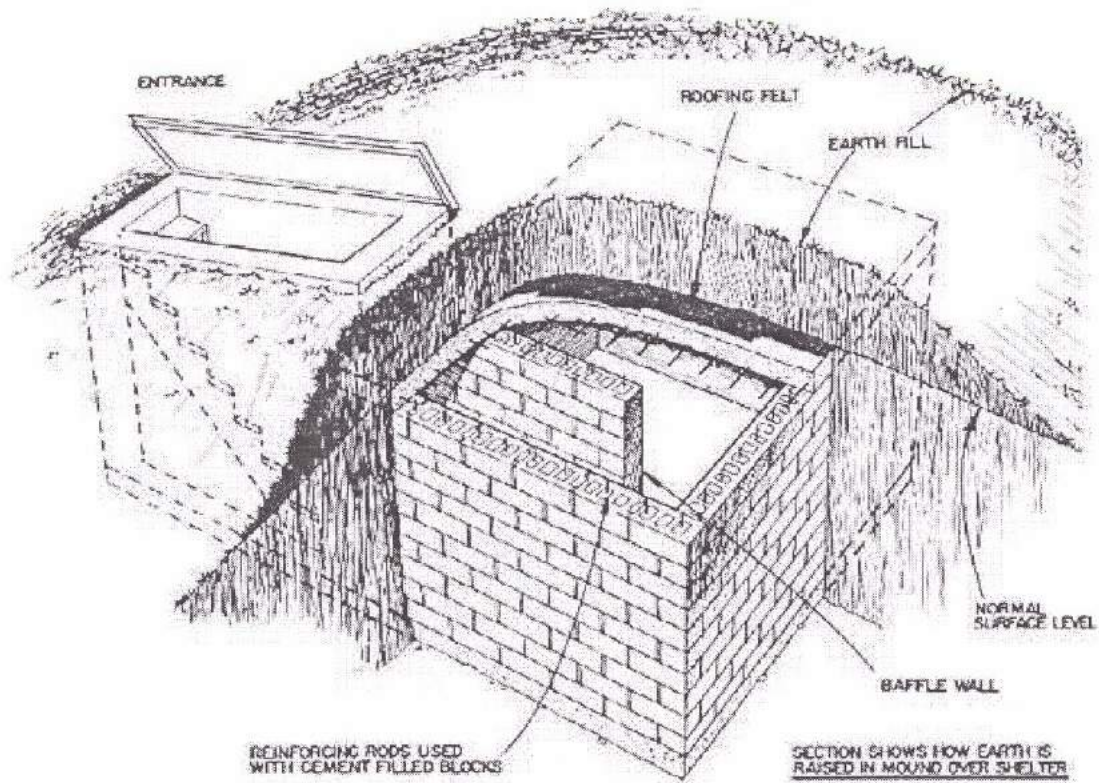

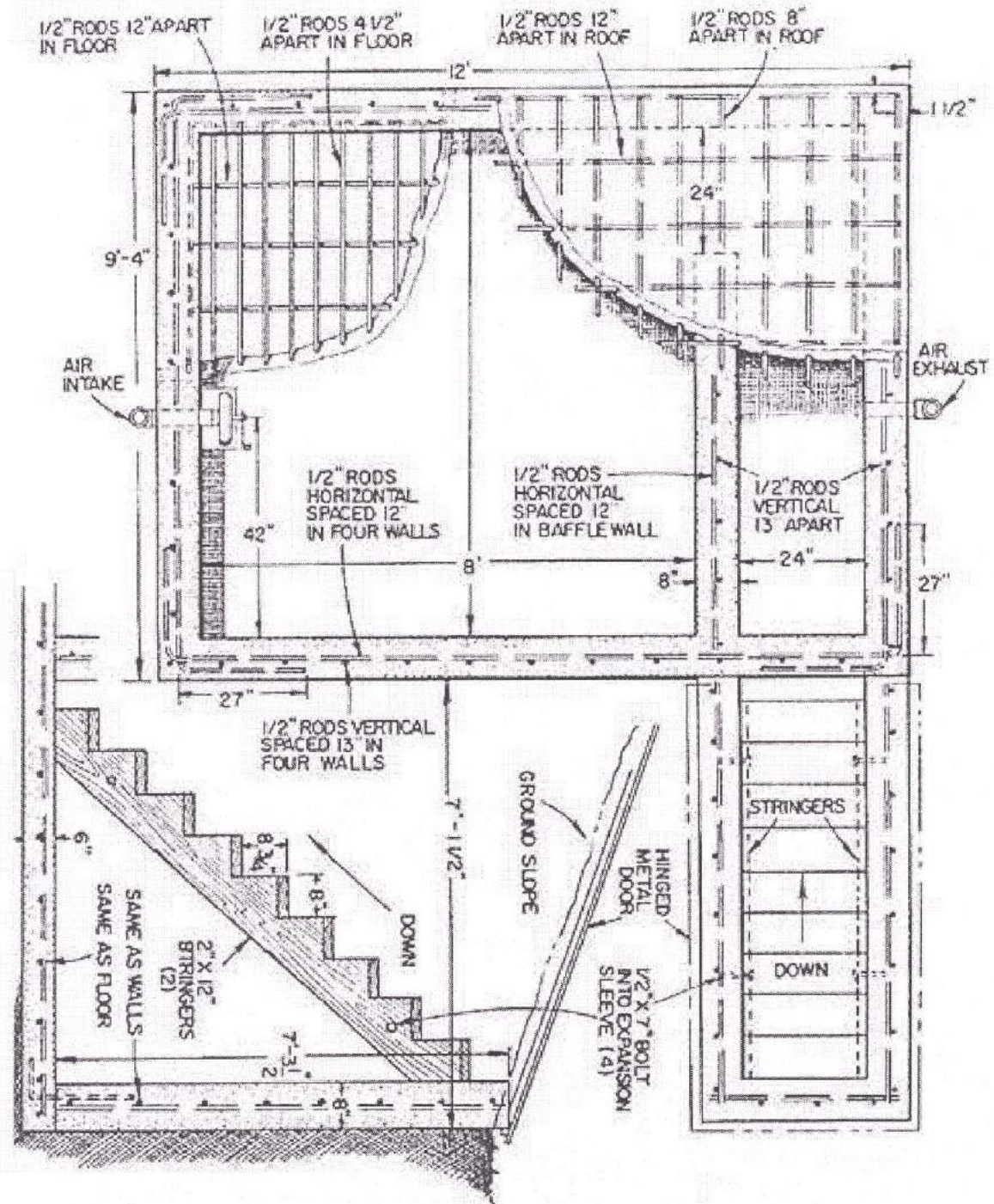

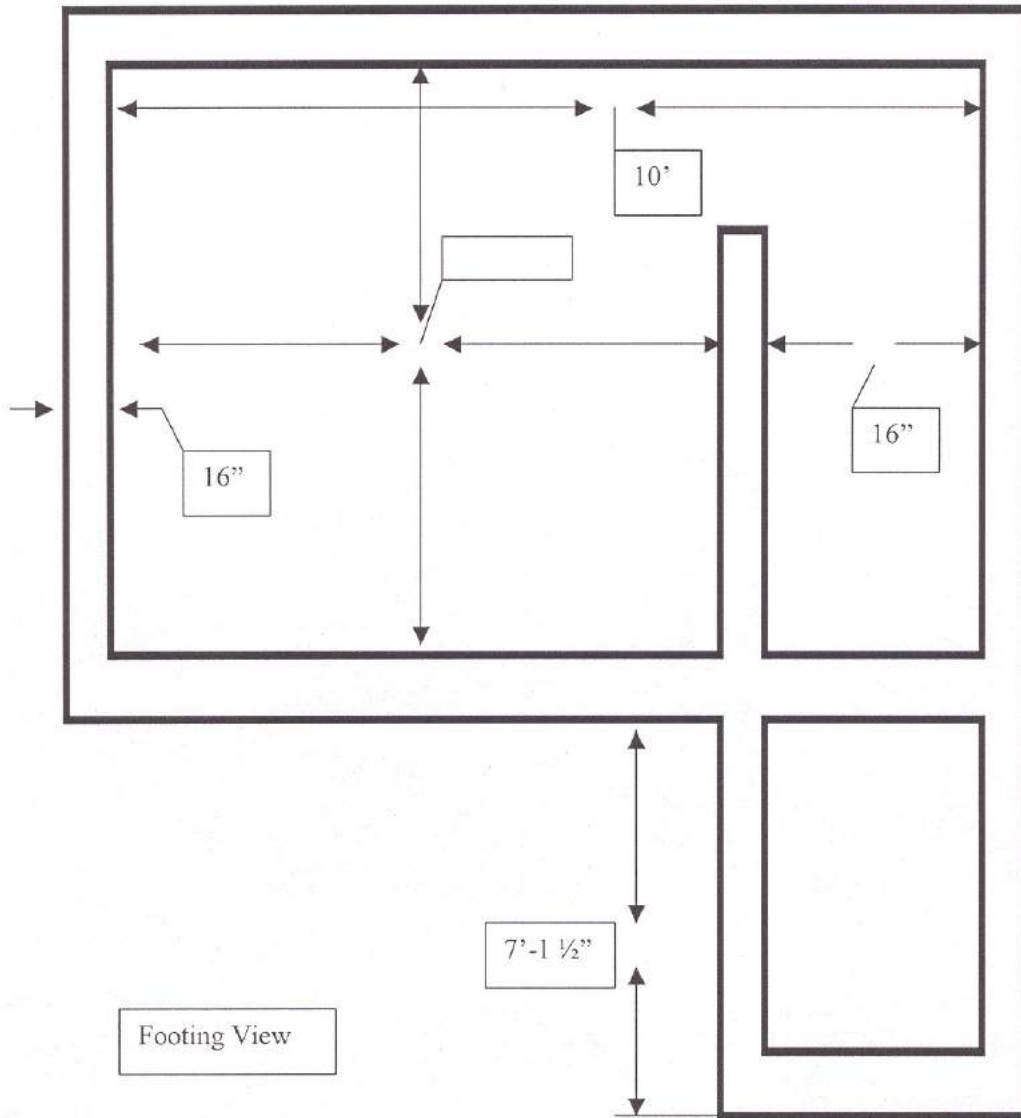

Electrical Systems & Lighting

An independent wind system can be very use full in charging an underground battery bank. Wind-driven blades atop a tower turn a generator to create direct current and send it through a buried cable to a utility shack or can be directly linked to a room in an underground shelter. The room must be separate from any other room occupied by people. The batteries can give off toxic gases and need to be vented.

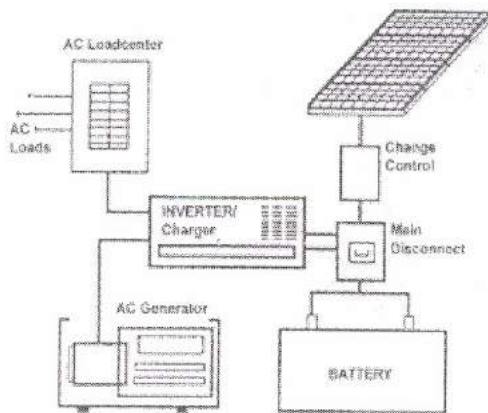
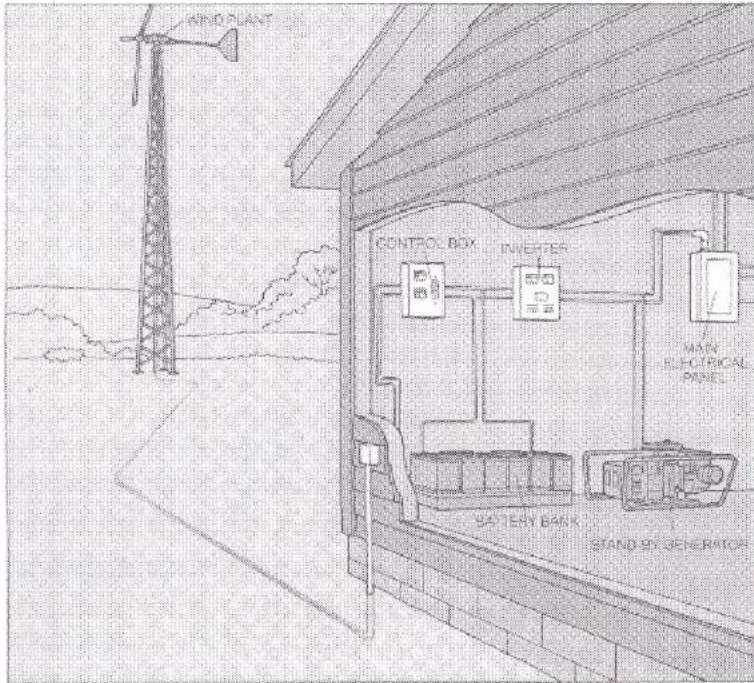

Figure 1 - Hybrid system

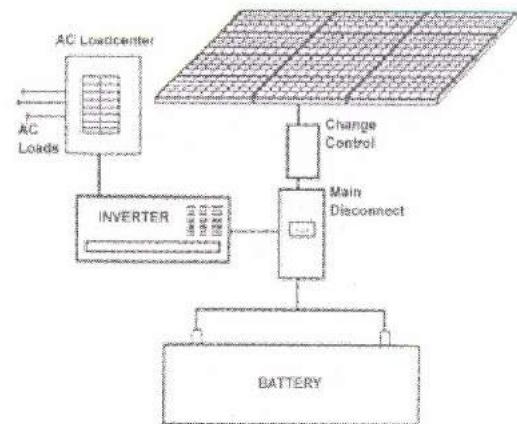

Figure 2 - Stand alone system

A control box-containing electronic circuitry-regulates the voltage to match that of a bank of storage batteries The control box also displays on its dials the volt age and amperage being produced by the system, and protects the batteries against excessive overcharging or discharging

Beyond the batteries an inverter converts the direct current to alternating current that can be fed into a conventional main electrical panel which contains circuit breakers to protect the shelter wiring from overloads or short circuits. You should have a standby diesel powered generator added into the wiring system. The generator will be use full when the batteries begin to loose charge. The generator is between the inverter and the service panel. Should a direct attack destroy the wind generating equipment, the generator can be run to power the shelters lights and appliances

Having a solar array with five solar panels, each composed of 24 disk like photovoltaic cells are joined within a sturdy frame to form a solar array. The output of a solar array is equal to the yields of all of the individual cells added together the array shown below, for example. will produce about 54 volts and 1 3 amperes-or about 70 watts-enough to power a small black-and-white television, radio and some low wattage lighting. If more power is required several arrays can be wired together through junction boxes on the backs of the panels.

To exploit all available sunlight arrays are mounted on south-facing racks angled to within 15 ' of the local latitude Like wind- and water-powered generating systems, photovoltaic systems also may be interconnected with utility lines or designed to stand alone, relying on a bank of batteries to store power for use during the night and on cloudy days

